

1J143

Female Seal-Lok® - Swivel - 90° Elbow - Long Drop

ISO 12151-1 - SWEL90

# Part Number	Thread		Hose I.D. inch	A		E		W inch	B	
	inch	mm		inch	mm	inch	mm		inch	mm
1J143-4-4	1/4	9/16x18	1/4	2.02	51	1.81	46	11/16	1.27	32
1J143-6-4	3/8	11/16x16	1/4	2.26	57	2.29	58	13/16	1.51	38
1J143-6-6	3/8	11/16x16	3/8	2.39	61	2.13	54	13/16	1.36	35
1J143-8-6	1/2	13/16x16	3/8	2.45	62	2.52	64	15/16	1.42	36
1J143-8-8	1/2	13/16x16	1/2	2.59	66	2.52	64	15/16	1.33	34
1J143-8-8-SM	1/2	13/16x16	1/2	2.59	66	2.52	64	24 mm	1.33	34
1J143-10-8	5/8	1x14	1/2	2.74	70	2.79	71	1-1/8	1.48	38
1J143-10-10	5/8	1x14	5/8	2.97	75	2.76	70	1-1/8	1.53	39
1J143-10-12	5/8	1x14	3/4	3.15	80	2.76	70	1-1/8	1.73	44
1J143-12-12	3/4	1-3/16x12	3/4	3.49	89	3.78	96	1-3/8	2.05	52
1J143-16-16	1	1-7/16x12	1	4.28	109	4.49	114	1-5/8	2.66	68
1J143-20-20	1-1/4	1-11/16x12	1-1/4	4.84	123	5.09	129	1-7/8	3.15	80
1J143-24-20	1-1/2	2x12	1-1/4	4.77	121	5.54	141	2-1/4	3.12	79

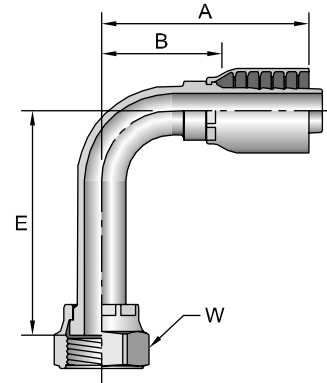

1D043

Male Metric L - Rigid - (24° Cone)

ISO 8434-1

# Part Number	Thread		Hose I.D. inch	A		H mm	B	
	mm	mm		inch	mm		inch	mm
1D043-6-4	6	M12x1,5	1/4	1.73	44	14	0.93	24
1D043-8-4	8	M14x1,5	1/4	1.61	41	14	0.93	24
1D043-10-5	10	M16x1,5	5/16	1.97	50	19	0.83	21
1D043-10-6	10	M16x1,5	3/8	1.97	50	19	0.83	21
1D043-12-5	12	M18x1,5	5/16	1.89	48	19	0.94	24
1D043-12-6	12	M18x1,5	3/8	1.97	50	19	0.83	21
1D043-15-6	15	M22x1,5	3/8	1.93	49	22	1.02	26
1D043-15-8	15	M22x1,5	1/2	2.28	58	22	0.94	24
1D043-18-10	18	M26x1,5	5/8	2.68	68	27	1.14	29
1D043-18-12	18	M26x1,5	3/4	2.68	68	27	1.14	29
1D043-22-12	22	M30x2	3/4	2.72	69	30	1.22	31
1D043-28-16	28	M36x2	1	3.11	79	36	1.30	33
1D043-35-20	35	M45x2	1-1/4	3.35	85	46	1.50	38

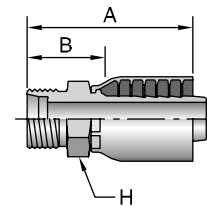

11D43

Male Standpipe Metric L - Rigid

ISO 8434-1

# Part Number	R mm	Hose I.D. inch	A		D		B	
			inch	mm	inch	mm	inch	mm
11D43-6-4	6	1/4	2.03	52	0.87	22	1.28	33
11D43-10-5	10	5/16	2.36	60	0.91	23	1.45	37
11D43-10-6	10	3/8	2.28	58	0.91	23	1.14	29
11D43-12-4	12	1/4	2.17	55	0.91	23	1.22	31
11D43-15-8	15	1/2	2.56	65	0.98	25	1.22	31
11D43-18-10	18	5/8	2.99	76	1.02	26	1.48	38
11D43-18-12	18	3/4	2.80	71	1.02	26	1.22	31
11D43-22-12	22	3/4	2.87	73	1.10	28	1.26	32
11D43-28-16	28	1	3.31	84	1.18	30	1.46	37

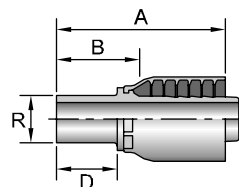

Metric L: Mates with EO "L" Series Fittings. See Accessories Section for O-Rings.

Hose
A

Fittings
43 Series
B

Equipment
C

Accessories
D

Technical
E

1C343

Female Metric L - Swivel - (Ball Nose)

ISO 8434-1

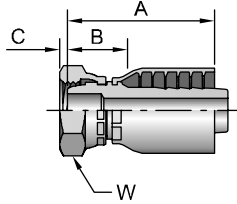

# Part Number	Thread		Hose I.D.	A		C		W	B	
	mm		inch	inch	mm	inch	mm	mm	inch	mm
1C343-6-4	6	M12x1,5	1/4	1.75	44	0.09	2	14	1.16	29
1C343-8-4	8	M14x1,5	1/4	1.77	45	0.11	3	17	1.16	29
1C343-10-5	10	M16x1,5	5/16	2.01	51	0.06	2	19	1.20	30
1C343-10-6	10	M16x1,5	3/8	2.06	52	0.06	2	19	1.10	28
1C343-12-5	12	M18x1,5	5/16	1.87	47	0.10	3	22	0.70	18
1C343-12-6	12	M18x1,5	3/8	2.23	57	0.10	3	22	1.18	30
1C343-15-6	6	M22x1,5	3/8	1.85	47	0.16	4	27	0.71	18
1C343-15-8	15	M22x1,5	1/2	2.42	61	0.17	4	27	1.29	33
1C343-18-10	18	M26x1,5	5/8	2.65	67	0.10	3	32	1.23	31
1C343-18-12	18	M26x1,5	3/4	2.80	71	0.10	3	32	1.37	35
1C343-22-12	22	M30x2	3/4	2.87	73	0.18	5	36	1.42	36
1C343-28-16	28	M36x2	1	3.35	85	0.22	6	46	1.76	45

When measuring overall length to the end of the nut, B+C dimensions must be used to calculate cut-off allowance.

1C443

Female Metric L - Swivel - 45° Elbow - (Ball Nose)

ISO 8434-1

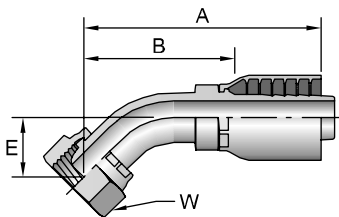

# Part Number	Thread		Hose I.D.	A		E		W	B	
	mm		inch	inch	mm	inch	mm	mm	inch	mm
1C443-8-4	8	M14x1,5	1/4	2.40	61	0.59	15	17	1.50	38
1C443-10-5	10	M16x1,5	5/16	2.60	66	0.67	17	19	1.61	41
1C443-10-6	10	M16x1,5	3/8	2.76	70	0.67	17	19	1.61	41
1C443-12-6	12	M18x1,5	3/8	2.76	70	0.67	17	22	1.61	41
1C443-15-8	15	M22x1,5	1/2	3.35	85	0.79	20	27	1.97	50
1C443-18-10	18	M26x1,5	5/8	4.09	104	1.14	29	32	2.52	64
1C443-22-12	22	M30x2	3/4	3.78	96	0.91	23	36	2.20	56
1C443-28-16	28	M36x2	1	4.53	115	1.10	28	46	2.81	71

1C543

Female Metric L - Swivel - 90° Elbow - (Ball Nose)

ISO 8434-1

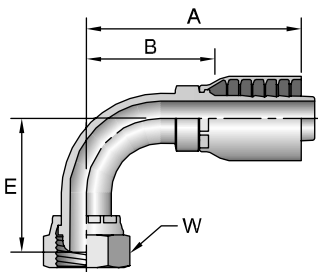

# Part Number	Thread		Hose I.D.	A		E		W	B	
	mm		inch	inch	mm	inch	mm	mm	inch	mm
1C543-8-4	8	M14x1,5	1/4	2.05	52	1.10	28	17	1.18	30
1C543-10-5	10	M16x1,5	5/16	2.20	56	1.18	30	19	1.22	31
1C543-10-6	10	M16x1,5	3/8	2.40	61	1.18	30	19	1.40	36
1C543-12-6	12	M18x1,5	3/8	2.40	61	1.22	31	22	1.40	36
1C543-15-8	15	M22x1,5	1/2	2.95	75	1.57	40	27	1.57	40
1C543-18-10	18	M26x1,5	5/8	3.58	91	2.36	60	32	2.05	52
1C543-22-12	22	M30x2	3/4	3.58	91	1.97	50	36	2.00	51
1C543-28-16	28	M36x2	1	4.33	110	2.48	63	46	2.56	65

Metric L: Mates with EO "L" Series Fittings.

1CA43

Female Metric L - Swivel - (24° Cone with O-Ring)

ISO 12151-2 - SWS

# Part Number	Thread mm	Hose I.D. inch	A		C		W mm	B	
			inch	mm	inch	mm		inch	mm
1CA43-6-4	6	M12x1,5	1/4	1.81	46	-0.02	14	1.06	27
1CA43-8-4	8	M14x1,5	1/4	1.68	43	-0.01	17	0.88	22
1CA43-8-5	8	M14x1,5	5/16	2.01	51	0.00	17	1.02	26
1CA43-10-4	10	M16x1,5	1/4	1.81	46	0.04	19	0.87	22
1CA43-10-5	10	M16x1,5	5/16	1.73	44	0.04	19	0.82	21
1CA43-12-5	12	M18x1,5	5/16	1.81	46	0.04	22	0.91	23
1CA43-12-6	12	M18x1,5	3/8	2.17	55	0.03	22	1.02	26
1CA43-15-8	15	M22x1,5	1/2	2.52	64	0.07	27	1.14	29
1CA43-18-10	18	M26x1,5	5/8	3.02	77	0.02	32	1.61	41
1CA43-18-12	18	M26x1,5	3/4	2.56	65	0.02	32	1.11	28
1CA43-22-12	22	M30x2	3/4	2.83	72	0.13	36	1.30	33
1CA43-28-16	28	M36x2	1	3.35	85	0.14	46	1.57	40
1CA43-35-20	35	M45x2	1-1/4	3.28	83	0.00	50	1.55	39

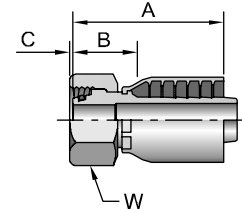

When measuring overall length to the end of the nut, B+C dimensions must be used to calculate cut-off allowance.

1CE43

Female Metric L - Swivel - 45° Elbow - (24° Cone with O-Ring)

ISO 12151-2 - SWE45

# Part Number	Thread mm	Hose I.D. inch	A		E		W mm	B	
			inch	mm	inch	mm		inch	mm
1CE43-6-4	6	M12x1,5	1/4	2.76	70	0.75	19	1.81	46
1CE43-8-4	8	M14x1,5	1/4	2.32	59	0.63	16	1.38	35
1CE43-10-5	10	M16x1,5	5/16	2.64	67	0.63	16	1.73	44
1CE43-10-6	10	M16x1,5	3/8	3.43	87	0.73	19	2.44	62
1CE43-12-6	12	M18x1,5	3/8	2.87	73	0.87	22	1.73	44
1CE43-15-8	15	M22x1,5	1/2	3.39	86	0.87	22	2.00	51
1CE43-18-10	18	M26x1,5	5/8	3.58	91	0.98	25	2.05	52
1CE43-22-12	22	M30x2	3/4	3.82	97	0.98	25	2.28	58

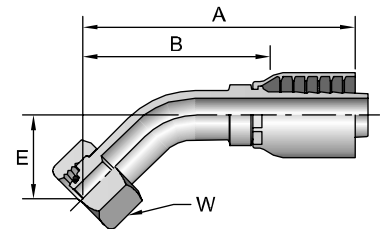

1CF43

Female Metric L - Swivel - 90° Elbow - (24° Cone with O-Ring)

ISO 12151-2 - SWE

# Part Number	Thread mm	Hose I.D. inch	A		E		W mm	B	
			inch	mm	inch	mm		inch	mm
1CF43-8-4	8	M14x1,5	1/4	2.01	51	1.14	29	1.10	28
1CF43-10-5	10	M16x1,5	5/16	2.3	58	1.16	29	1.46	37
1CF43-10-6	10	M16x1,5	3/8	2.56	65	1.38	35	1.58	40
1CF43-12-5	12	M18x1,5	5/16	2.40	61	1.18	30	1.46	37
1CF43-12-6	12	M18x1,5	3/8	2.40	61	1.22	31	1.40	36
1CF43-15-8	15	M22x1,5	1/2	2.95	75	1.65	42	1.57	40
1CF43-18-10	18	M26x1,5	5/8	3.17	81	1.77	45	1.71	43
1CF43-22-12	22	M30x2	3/4	3.54	90	2.09	53	2.00	51
1CF43-35-20	35	M45x2	1-1/4	4.72	120	3.11	79	2.87	73

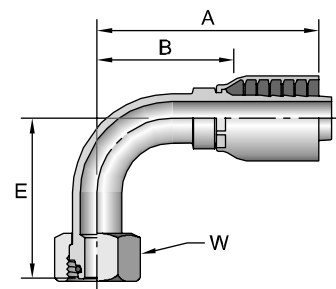

Metric L: Mates with EO "L" Series Fittings.

Hose
A

Fittings
43 Series
B

Equipment
C

Accessories
D

Technical
E