

The XFC Series

Extreme Force Roller Screw Driven Electric Cylinders

Design Features

- Pre-engineered package
- Performance matched components
- Environmental protection
- Laser certified precision
- All steel construction with standard metric hydraulic type tie rod construction for durability, stiffness, and rigidity
- Elastomeric seals throughout with no gaskets for complete sealing
- Opposed preloaded angular contact bearings for bi-directional force capability
- Roller screw drive system for increased life, load, and shock loading capabilities
- Inline and parallel gear drive configurations for full transfer of thrust force
- Parker Stealth family advanced planetary gearheads direct mount to cylinder for standard reduction options from 3:1 to 10:1 with 100:1 available
- Parker MPP Series brushless servo motors for complete Parker system solution with gearhead, motor, drive, and controls
- Rod wiper and seal based on proven TS2000 design and composite rod bearing designed to survive rugged environments with minimal maintenance for the life of the cylinder



- High mechanical efficiency up to 90%
- Strokes up to 2000mm
- Extreme thrust force up to 356,000 N / 80,000 lbs
- Repeatability up to ±0.03mm
- Speeds up to 1016 mm/s
- Six metric profile sizes: 075, 090, 115, 140, 165, 190
- Anti-rotate option

Electric Cylinders

	075	090	115	140	165	190
Maximum Travel (mm)	1,150	1,700	2,000	2,000	2,000	2,000
Maximum Payload (N)	40,000	68,000	108,000	160,000	240,000	356,000
Maximum Acceleration (m/sec ²)	1,016	712	548	444	712	568

Parker is pleased to offer a family of high thrust electric cylinders featuring roller screw drive technology. The XFC Series further extends the feature rich and force dense offering of Parker’s electric cylinder products. The XFC Electric Cylinder is designed to provide machine builders a high

force electromechanical solution: offering long life, minimal maintenance, low operating costs, and structural rigidity. All this, in addition to Parker’s world class customer service and industry leading delivery times.

As a worldwide leader in fluid

power cylinder products, Parker has combined the best of both worlds into one unique product. All the benefits of electromechanical control and cleanliness combined with the structural rigidity and durability of a traditional hydraulic tie rod cylinder.

Flexibility & Versatile Programmability

In applications where high loads are required, roller screws offer a very attractive solution:

- **Servo motors and controls feature simplified programming**
- **Electromechanical control systems provide infinite programmability**
- **Performance advantages not easily obtained by comparable fluid power technology include multiple move profiles, adjustable acceleration and deceleration, force control, and absolute positioning capabilities**

These features allow the system to easily adapt to changing application conditions and performance requirements with minimal modification.

Design Considerations

Installation

Due to the reduced number of components required for a complete system, the commissioning time required for operation is significantly reduced relative to comparable fluid power systems. This allows system builders to quickly install, troubleshoot, and test system capabilities faster and more reliably than other alternatives.

Additionally machine break-down and set-up can be accomplished with relative ease and without concern of hydraulic fluid spillage.

Environmental Considerations

With electromechanical system technology, fluid leaks, filter changes, and air bleeding are a

thing of the past. Simply mount the cylinder, plug in the cables, download a program and you are up and running in record time.

Anti-Rotation

Anti-rotation can now be achieved in XFC actuators thanks to a new design that incorporates a keying feature on the internal surface of the tubular body. This option can be configured through our standard part number structure.

Maintenance

Roller screw cylinder systems require little or no maintenance when compared to their fluid power alternatives, while still delivering long life and high performance. Series XFC cylinders are designed to be low maintenance with the factory installed full synthetic lubrication. For high duty cycle applications (>50%), oil filled cylinders are available with ports for recirculation as required.

A Look Inside the XFC Roller Screw: Technology Advantages

Planetary roller screws offer distinct benefits over traditional ball screw and lead screw mechanisms, and add features not easily attainable with hydraulic or pneumatic linear devices.

A planetary roller screw transmits rotary motion into linear motion similar to a ball or lead screw. The key difference in the roller screw design is the use of planetary rollers in place of ball bearings as the primary rolling elements.

The planetary rollers provide an increased number of contact surfaces between the external screw shaft and the internal threads of the roller nut relative to traditional ball or lead screw technology. The expanded number of contact points allow for:

- **Enhanced thrust capacity – 5X more thrust!**
- **Enhanced load carrying capabilities**
- **Higher speeds than traditional hydraulic cylinders**
- **Greatly extended life – 10X longer life!**

SPECIFICATIONS

SPECIFICATIONS



Performance

XFC Frame Size		075	090	115	140	165	190
Continuous Thrust	kN	20	34	54	80	120	178
	(lbs)	(4,500)	(7,500)	(12,000)	(17,500)	(26,500)	(40,000)
Maximum Thrust	kN	40	68	108	160	240	356
	(lbs)	(9,000)	(15,000)	(24,000)	(35,000)	(53,000)	(80,000)
Maximum Acceleration	mm/sec ²	19,600	19,600	19,600	19,600	19,600	19,600
	(in/sec ²)	(773)	(773)	(773)	(773)	(773)	(773)
Maximum Stroke ¹⁾	mm	1150	1700	2,000	2,000	2,000	2,000
	(in)	(55.12)	(66.93)	(78.75)	(78.75)	(78.75)	(78.75)
Recommended Maximum Stroke Length of Unsupported Cylinder ²⁾	mm	750	750	750	1,000	1,000	1,250
	(in)	(29.53)	(29.53)	(29.53)	(39.37)	(39.37)	(49.21)

1) Consult factory for non-standard stroke lengths

2) Secondary support required for longer stroke lengths (consult factory)

System Characteristics

XFC Frame Size		075	090	115	140	165	190
Accuracy	mm	0.08	0.08	0.08	0.08	0.13	0.13
	(in)	(0.003)	(0.003)	(0.003)	(0.003)	(0.005)	(0.005)
Repeatability	mm	0.03	0.03	0.03	0.03	0.05	0.05
	(in)	(0.001)	(0.001)	(0.001)	(0.001)	(0.002)	(0.002)
Backlash	mm	0.03	0.03	0.03	0.03	0.03	0.03
	(in)	(0.001)	(0.001)	(0.001)	(0.001)	(0.001)	(0.001)

Screw Characteristics

XFC Size	Screw Diameter mm	Standard Lead ¹⁾ mm (in)/rev	Efficiency %	Ca Rating kN (lbf)	Thrust Tube	
					Torque mN-m/N (lb-in/lbf)	Max. Speed ²⁾ mm/sec (in/sec)
075	21	5 (0.197)	88.78	40.4 (9,082)	0.889 (0.035)	508 (20.0)
		10 (0.394)	91.17	44.6 (10,026)	1.752 (0.069)	1016 (40.0)
090	30	5 (0.197)	87.05	73.6 (16,546)	0.914 (0.036)	356 (14.0)
		10 (0.394)	90.38	74.4 (16,726)	1.752 (0.069)	712 (28.0)
115	39	5 (0.197)	85.18	103.4 (23,245)	0.939 (0.037)	274 (10.8)
		10 (0.394)	89.37	116.5 (26,190)	1.778 (0.070)	548 (21.6)
140	48	5 (0.197)	82.50	158.5 (35,632)	0.965 (0.038)	222 (8.7)
		10 (0.394)	88.34	171.2 (38,487)	1.803 (0.071)	444 (17.4)
165	60	10 (0.394)	87.05	238.6 (53,639)	1.829 (0.072)	356 (14.0)
		20 (0.787)	90.38	238.6 (53,639)	3.531 (0.139)	712 (28.0)
190	75	10 (0.394)	85.45	356.5 (80,144)	1.854 (0.073)	284 (11.2)
		20 (0.787)	90.97	356.5 (80,144)	3.658 (0.144)	568 (22.4)

1) Consult factory for availability of non-standard leads

2) Speed is stroke dependant, see Maximum Speed charts for speed/stroke chart

Cylinder Temperature Rating*

Standard seals	-23 to 73°C (-10 to 165°F)
Fluorocarbon seals	-23 to 110°C (-10 to 230°F)

* Verify motor and gear box performance at higher temperatures.

Cylinder Weight — kg (lb)

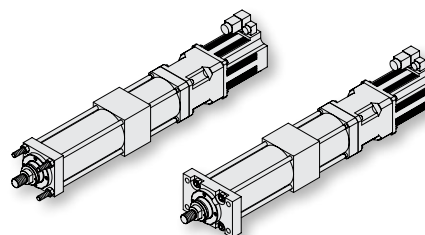

Inline Configurations

XFC Frame Size	Base Weight with Mount (at Zero Stroke)				Weight (Per 100 mm Stroke)
	J Front Flange	C Foot	D Trunnion	K Extended Tie Rod	
075	9.1 (20)	9.1 (20)	9.5 (21)	8.6 (19)	1.41 (3.1)
090	14.5 (32)	14.1 (31)	14.5 (32)	14.1 (31)	1.93 (4.3)
115	27.7 (61)	27.7 (61)	28.1 (62)	26.8 (59)	3.08 (6.8)
140	48.1 (106)	47.6 (105)	49.4 (109)	46.7 (103)	4.53 (10.0)
165	103.4 (182)	102.1 (180)	104.3 (185)	100.2 (175)	7.17 (15.8)
190	132.9 (293)	131.5 (290)	134.3 (296)	127.0 (280)	9.48 (20.9)

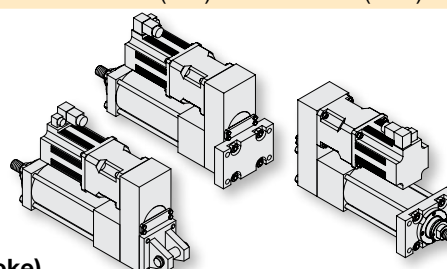

Parallel Configurations

XFC Frame Size	Base Weight with Mount (at Zero Stroke)						Weight (Per 100 mm Stroke)
	J Front Flange	C Foot	D Trunnion	K, L, M Extended Tie Rod	H Rear Flange	B Rear Clevis	
075	11.3 (25)	10.9 (24)	11.3 (25)	10.9 (24)	11.3 (25)	11.3 (25)	1.41 (3.1)
090	17.7 (39)	17.2 (38)	17.7 (39)	17.2 (38)	18.1 (40)	18.6 (41)	1.93 (4.3)
115	34.0 (75)	34.0 (75)	34.9 (77)	33.1 (73)	35.4 (78)	35.4 (78)	3.08 (6.8)
140	59.4 (131)	58.5 (129)	60.3 (133)	57.6 (127)	61.7 (136)	62.1 (137)	4.53 (10.0)
165	103.4 (228)	102.1 (225)	104.3 (230)	100.2 (221)	107.0 (236)	110.7 (244)	7.17 (15.8)
190	163.7 (361)	162.4 (358)	170.6 (376)	158.8 (350)	171.5 (378)	171.9 (379)	9.48 (20.9)

Note: All weights above assume oil filled lubrication

Cylinder Inertia

Inertia matching of the cylinder assembly to the motor will improve the performance of the mechanical system. The inertia ratio of the cylinder and load to the motor should be less than 10:1. A general rule for screw driven systems is 5:1.

$$I_{\text{Total}} = I_{\text{GearHead}} + \frac{(I_{\text{XFC}} + I_{\text{Mass}})}{(\text{GearHeadRatio})^2}$$

$$I_{\text{Mass}} = \text{Mass}_{\text{Load}} \text{ (kg)} \left(\frac{\text{Lead (mm)}}{3141.6} \right)^3$$

For PS Series gearhead inertia information, see: www.parkermotion.com

XFC Inertia I (kg-m²)

XFC Size	Inline (Zero Stroke)	Parallel (Zero Stroke)	Stroke (Per 100 mm)
075	0.00008903	0.00037951	0.00001499
090	0.00031974	0.00089394	0.00006242
115	0.00107620	0.00349671	0.00017800
140	0.00229637	0.00923002	0.00040900
165	0.00655544	0.02428162	0.00099900
190	0.02702120	0.05552601	0.00244000

Life Charts

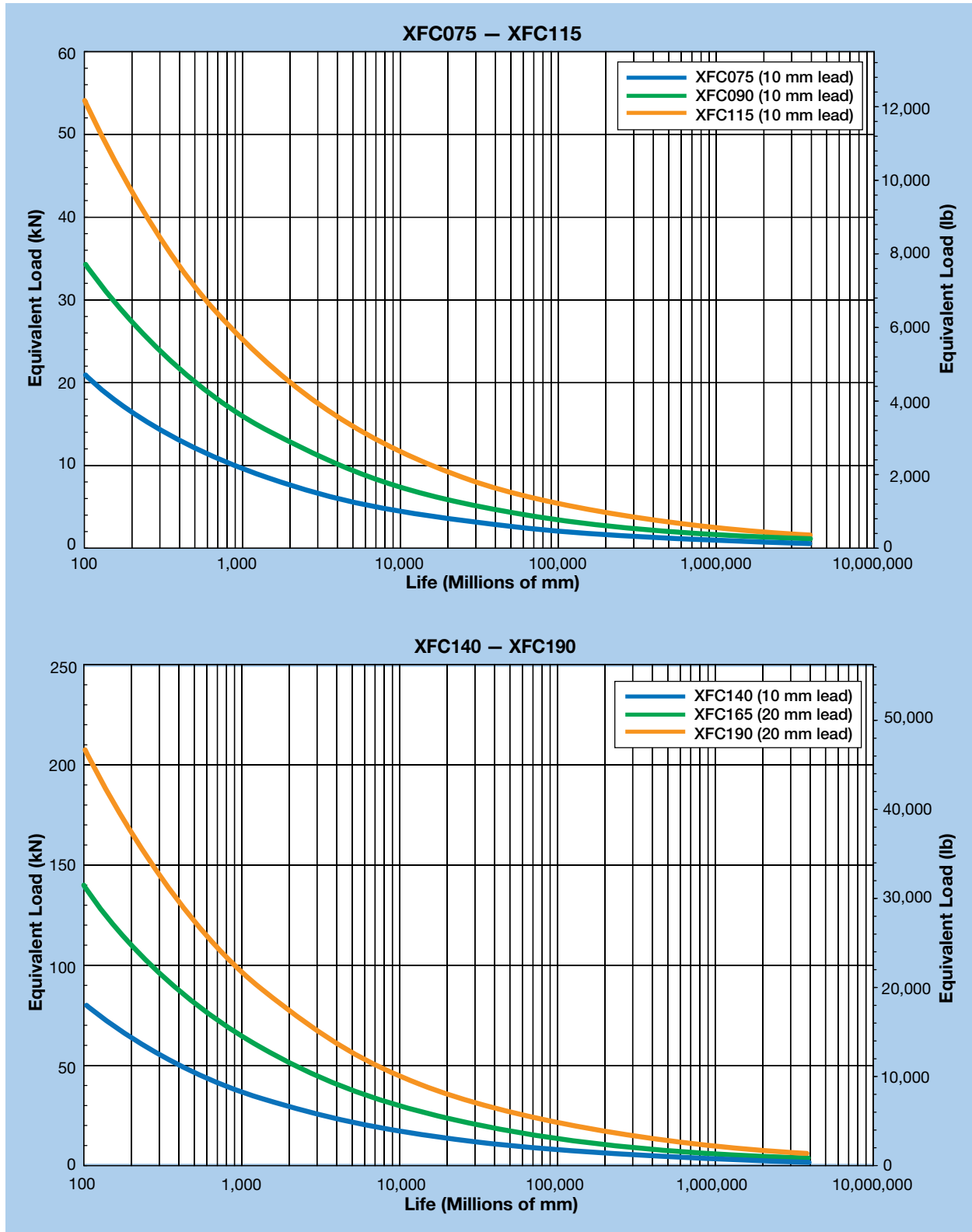

Electric
Cylinders

Maximum Speed Charts

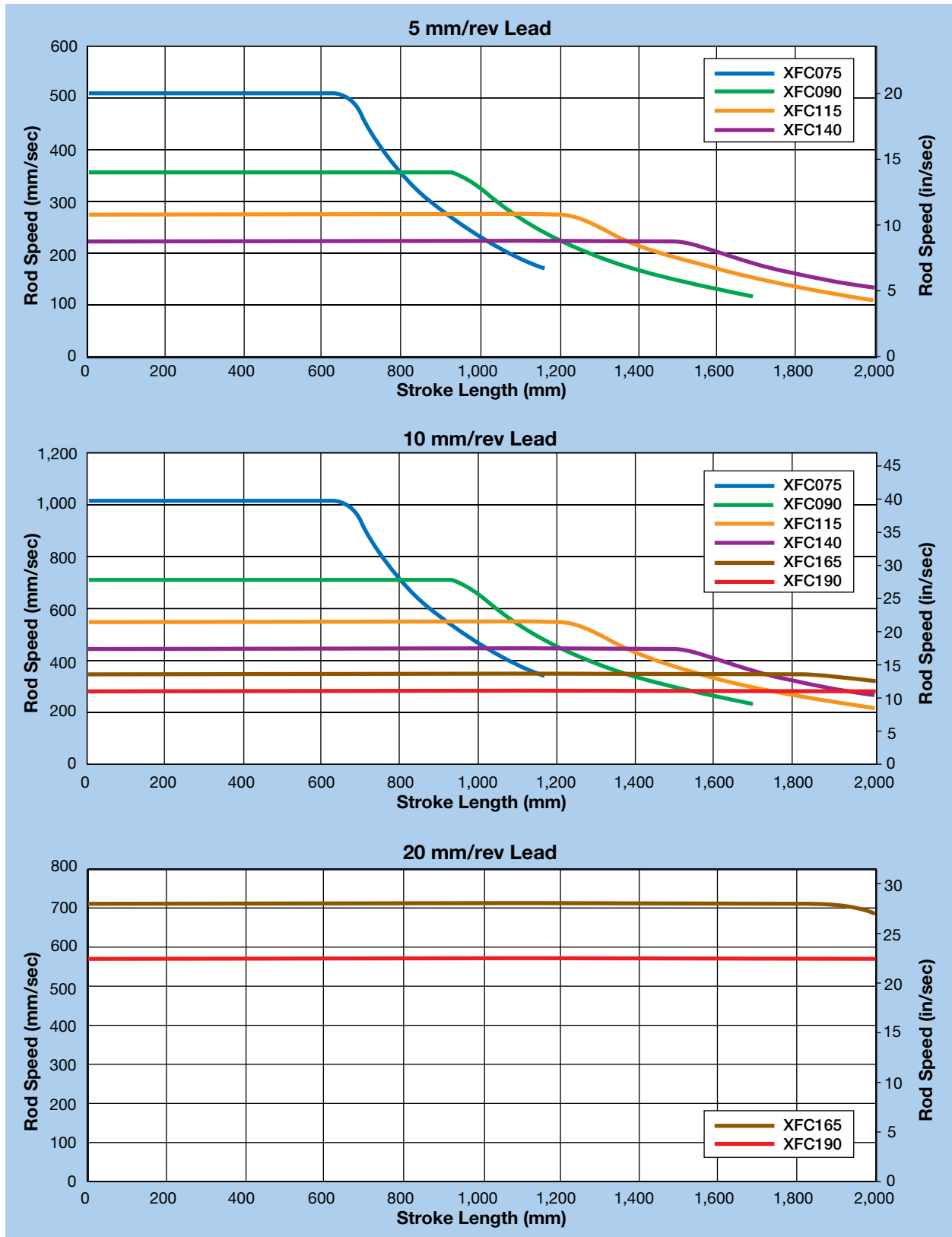

Buckling Strength Charts

The buckling strength of the cylinder is the maximum compressive load able to be exerted through the cylinder. These values are a

function of the screw and thrust tube size and do not account for specific motor or gearbox performance. The force value from the specific mounting class

and length of stroke should not be exceeded to ensure safe mechanical performance. Tension loads are not subject to buckling strength restrictions.

Maximum Compressive Force – Fixed Mount, Guided

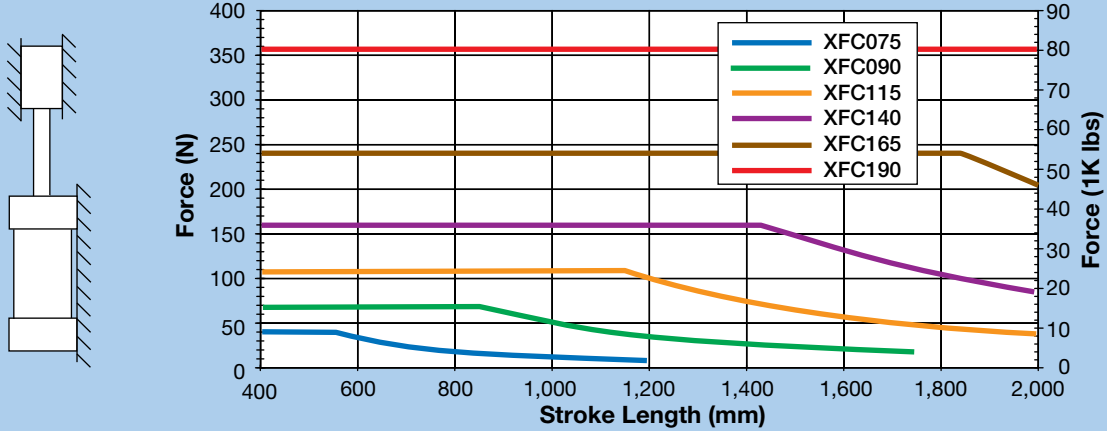

Maximum Compressive Force – Fixed Mount, Not Guided

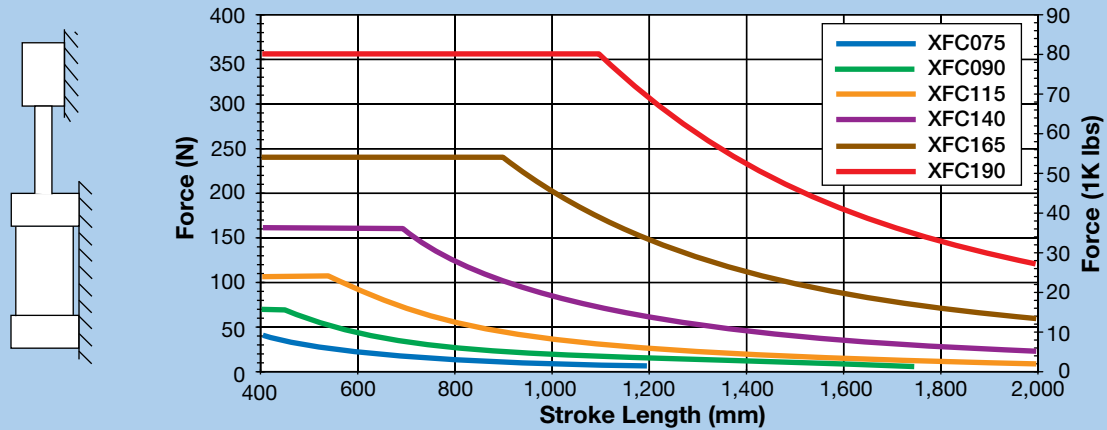

Maximum Compressive Force – Rear Pivot Mount, Guided

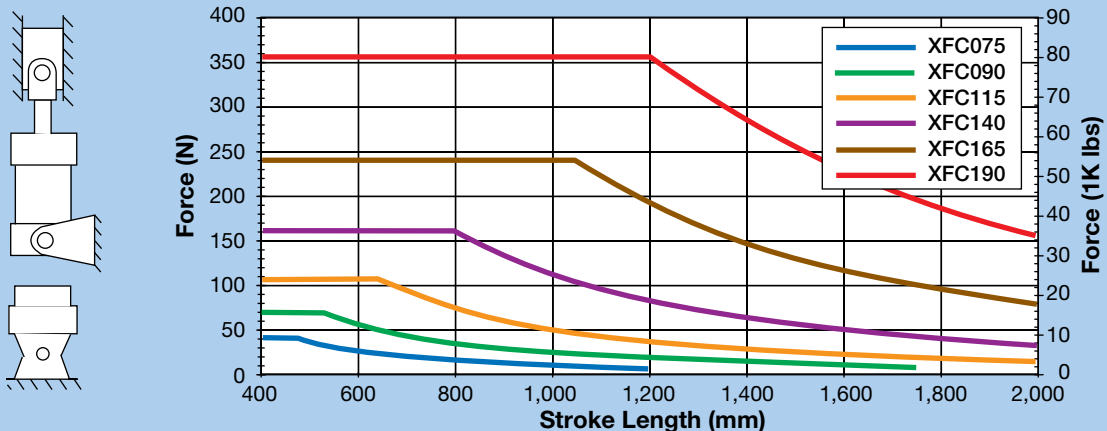

Electric
Cylinders

Available Mounts

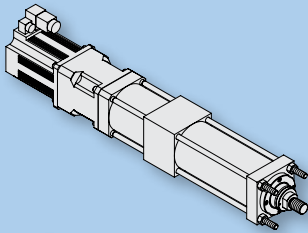
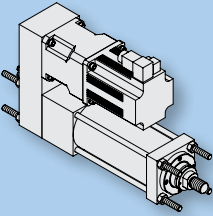
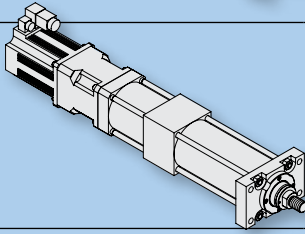
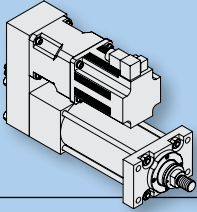
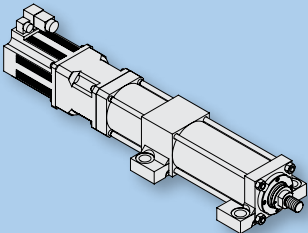
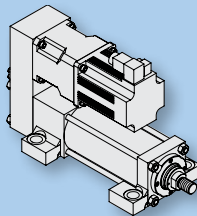
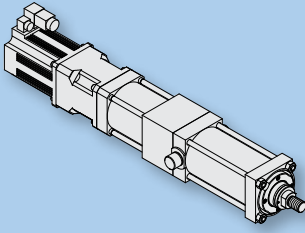
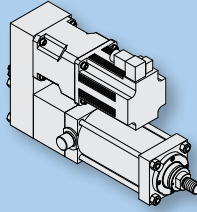
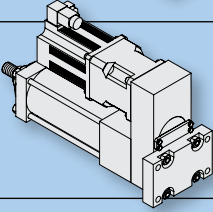
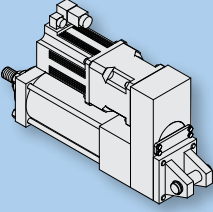
	Inline	Parallel
<p>K, L, M Extended Tie Rod Mount</p> <p>Cylinders with Extended Tie Rods are suitable for straight line force applications, and are particularly useful where space is limited.</p> <p>K Front Mount (inline and parallel) L Rear Mount (parallel only) M Both Front & Rear Mount (parallel only)</p>		
<p>J Integral Front Flange Mount</p> <p>These cylinders are suitable for use on straight line force transfer applications.</p> <p>J Front Flange Mount (inline and parallel)</p>		
<p>Foot Mount</p> <p>Foot mounted cylinders do not absorb forces along their center line. As a result, the application of force by the cylinder produces a moment which attempts to rotate the cylinder about its mounting bolts. It is therefore very important that the cylinder be firmly secured to the mounting surface and the load should be rigidly guided to avoid side loads being applied to the cylinder bearings.</p> <p>C Foot Mount (inline and parallel)</p>		
<p>T Rear Trunnion Mount</p> <p>Trunnion mounting is used for rotary or arc-line motion and offer flexibility when designing applications that are not confined to linear movements. Consult factory to review specific applications for stroke and configuration.</p> <p>T Rear Trunnion Mount (inline and parallel)</p>		
<p>H Rear Flange Mount</p> <p>These cylinders are suitable for use on straight line force transfer applications.</p> <p>H Rear Flange Mount (parallel only)</p>		
<p>B Rear Clevis Mount</p> <p>Cylinders with pivot mountings, which absorb forces on their center lines, should be used where the machine member to be moved travels in a curved path. Pivot mountings may be used in tension (pull) or compression (push) applications. Cylinders using a fixed clevis may be used if the curved path of the thrust tube travels in a single plane.</p> <p>B Rear Clevis Mount (parallel only)</p>		

DIMENSIONS

XFC Mount Options

Extended Tie Rod Mount — Inline

Order Code



K Front Extended Tie Rods

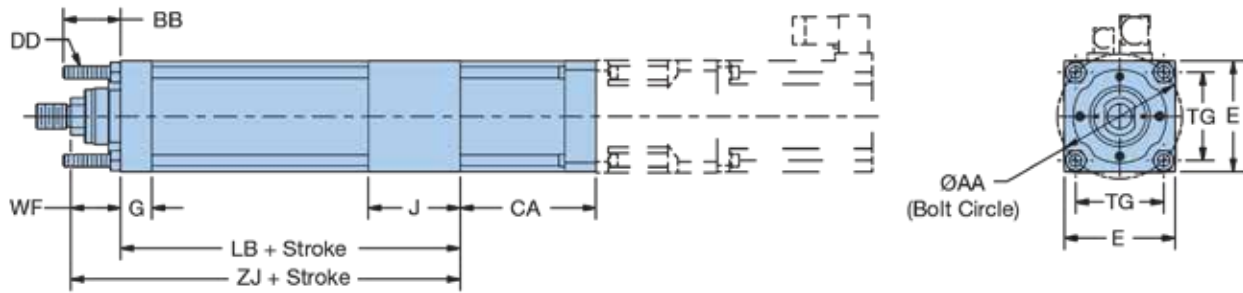

Dimensions — mm (in)

XFC Size	Ø AA	BB	DD	E	G	J	TG	WF	Add Stroke	
									LB	ZJ
075	83 (3.27)	30 (1.18)	M8x1	76.2 (3.00)	22 (0.87)	62 (2.44)	58.69 (2.31)	38 (1.50)	205.5 (8.09)	243.5 (9.59)
090	100 (3.94)	35 (1.38)	M10x1.5	88.9 (3.50)	25 (0.98)	74 (2.91)	70.71 (2.78)	40 (1.57)	248 (9.76)	288 (11.34)
115	127 (5.00)	40 (1.57)	M12x1.25	114.3 (4.50)	30 (1.18)	91 (3.58)	89.80 (3.54)	45 (1.77)	293 (11.54)	338 (13.31)
140	155 (6.10)	50 (1.97)	M16x1.5	139.7 (5.50)	35 (1.38)	108 (4.25)	109.60 (4.32)	45 (1.77)	348 (13.70)	393 (15.47)
165	185 (7.28)	60 (2.36)	M22x1.5	165.1 (6.50)	40 (1.57)	123 (4.84)	130.81 (5.15)	60 (2.36)	417 (16.42)	477 (18.78)
190	215 (8.46)	75 (2.95)	M22x1.5	190.5 (7.50)	50 (1.97)	152 (5.98)	152.03 (5.99)	62 (2.44)	503 (19.80)	565 (22.24)

Motor/Gearhead

XFC Size	Dimension CA								
	PS090	PS115	PS142	PS180	PS220	MPP115	MPP142	MPP190	MPP270
075	113 (4.45)	115 (4.53)	—	—	—	98 (3.86)	109 (4.29)	—	—
090	115 (4.53)	117 (4.61)	—	—	—	100 (3.94)	111 (4.37)	—	—
115	—	130 (5.12)	158 (6.22)	—	—	—	113 (4.45)	136 (5.35)	—
140	—	—	161 (6.34)	190 (7.48)	—	—	—	139 (5.47)	—
165	—	—	164 (6.46)	193 (7.60)	—	—	—	—	183 (7.20)
190	—	—	—	194 (7.64)	—	—	—	—	214 (8.43)

Free sizing and selection support from Virtual Engineer at parker.com/VirtualEngineer



Parallel Extended Tie Rod Mount — Parallel

Order Code



- K** Front Extended Tie Rods
- L** Rear Extended Tie Rods
- M** Both Front & Rear Extended Tie Rods

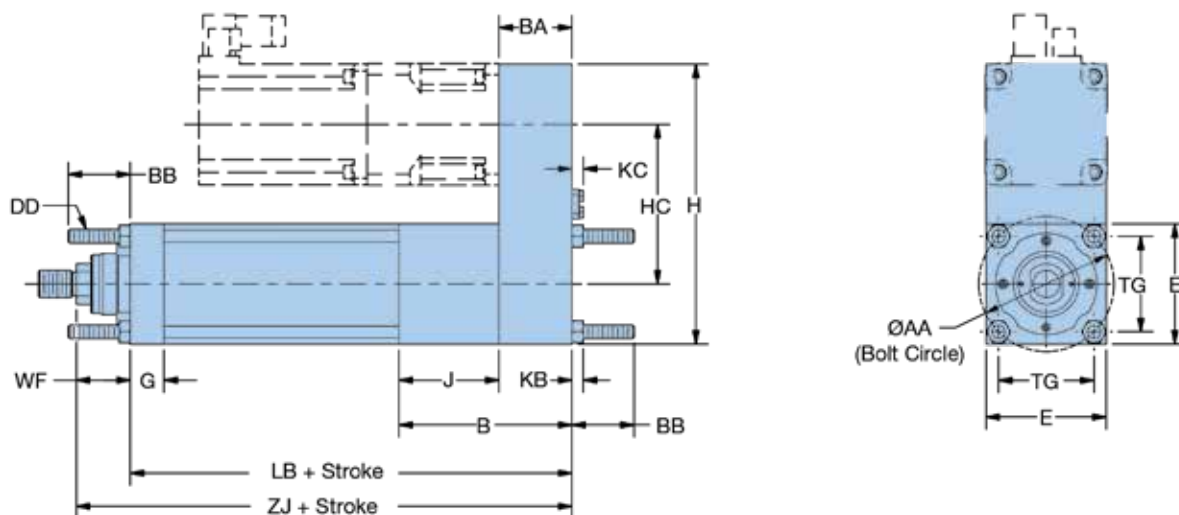

Dimensions — mm (in)

XFC Size	Ø AA	B	BA	BB	DD	E	G	H
075	83 (3.27)	106 (4.17)	44 (1.73)	30 (1.18)	M8x1	76.2 (3.00)	22 (0.87)	174.2 (6.86)
090	100 (3.94)	128 (5.04)	54 (2.13)	35 (1.38)	M10x1.5	88.9 (3.50)	25 (0.98)	206.9 (8.15)
115	127 (5.00)	154 (6.06)	63 (2.48)	40 (1.57)	M12x1.25	114.3 (4.50)	30 (1.18)	271 (10.67)
140	155 (6.10)	180 (7.09)	72 (2.83)	50 (1.97)	M16x1.5	139.7 (5.50)	35 (1.38)	332.2 (13.08)
165	185 (7.28)	211 (8.31)	88 (3.46)	60 (2.36)	M22x1.5	165.1 (6.50)	40 (1.57)	379.1 (14.93)
190	215 (8.46)	252 (9.92)	100 (3.94)	75 (2.95)	M22x1.5	190.5 (7.50)	50 (1.97)	455.5 (17.93)

XFC Size	Add Stroke							
	HC	J	KB	KC	TG	WF	LB	ZJ
075	98 (3.86)	62 (2.44)	6.5 (0.26)	6.93 (0.27)	58.69 (2.31)	38 (1.50)	249.5 (9.82)	287.5 (11.32)
090	118 (4.65)	74 (2.91)	8 (0.31)	8.65 (0.34)	70.71 (2.78)	40 (1.57)	302 (11.89)	342 (13.46)
115	156 (6.14)	91 (3.58)	10 (0.39)	10.15 (0.40)	89.80 (3.54)	45 (1.77)	356 (14.02)	401 (15.79)
140	192.5 (7.58)	108 (4.25)	13 (0.51)	13.65 (0.54)	109.60 (4.32)	45 (1.77)	420 (16.54)	465 (18.31)
165	224 (8.82)	123 (4.84)	18 (0.71)	13.65 (0.54)	130.81 (5.15)	60 (2.36)	505 (19.88)	565 (22.24)
190	265 (10.43)	152 (5.98)	18 (0.71)	17.18 (0.68)	152.03 (5.99)	62 (2.44)	603 (23.74)	665 (26.18)

Front Flange Mount — Inline

Order Code



J

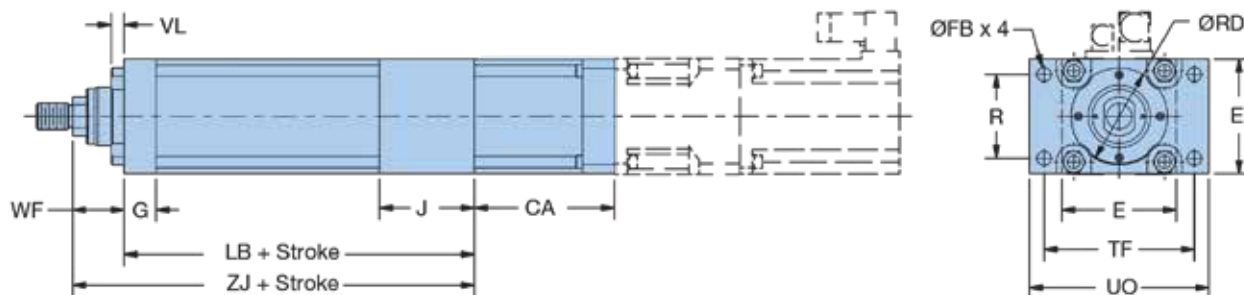

Dimensions — mm (in)

XFC Size	E	Ø FB	G	J	R	Ø RD _{FB}	TF	UO	VL	WF	Add Stroke	
											LB	ZJ
075	76.2 (3.00)	9 (0.35)	22 (0.87)	62 (2.44)	52 (2.05)	65 (2.559)	105 (4.13)	125 (4.92)	10 (0.39)	38 (1.50)	205.5 (8.09)	243.5 (9.59)
090	88.9 (3.50)	11 (0.43)	25 (0.98)	74 (2.91)	65 (2.56)	75 (2.953)	117 (4.61)	139.7 (5.50)	10 (0.39)	40 (1.57)	248 (9.76)	288 (11.34)
115	114.3 (4.50)	14 (0.55)	30 (1.18)	91 (3.58)	83 (3.27)	95 (3.740)	149 (5.87)	175 (6.89)	12 (0.47)	45 (1.77)	293 (11.54)	338 (13.31)
140	139.7 (5.50)	18 (0.71)	35 (1.38)	108 (4.25)	107 (4.21)	110 (4.331)	172 (6.77)	210 (8.27)	12 (0.47)	45 (1.77)	348 (13.70)	393 (15.47)
165	165.1 (6.50)	21 (0.83)	40 (1.57)	123 (4.84)	120 (4.72)	135 (5.315)	215 (8.46)	260 (10.24)	14 (0.55)	60 (2.36)	417 (16.42)	477 (18.78)
190	190.5 (7.50)	22 (0.87)	50 (1.97)	152 (5.98)	155 (6.10)	155 (5.315)	253 (9.96)	300 (11.81)	16 (0.63)	62 (2.44)	503 (19.80)	565 (22.24)

Motor/Gearhead

XFC Size	Dimension CA								
	PS090	PS115	PS142	PS180	PS220	MPP115	MPP142	MPP190	MPP270
075	113 (4.45)	115 (4.53)	—	—	—	98 (3.86)	109 (4.29)	—	—
090	115 (4.53)	117 (4.61)	—	—	—	100 (3.94)	111 (4.37)	—	—
115	—	130 (5.12)	158 (6.22)	—	—	—	113 (4.45)	136 (5.35)	—
140	—	—	161 (6.34)	190 (7.48)	—	—	—	139 (5.47)	—
165	—	—	164 (6.46)	193 (7.60)	—	—	—	—	183 (7.20)
190	—	—	—	194 (7.64)	—	—	—	—	214 (8.43)

Electric Cylinders

Front Flange Mount — Parallel

Order Code



J

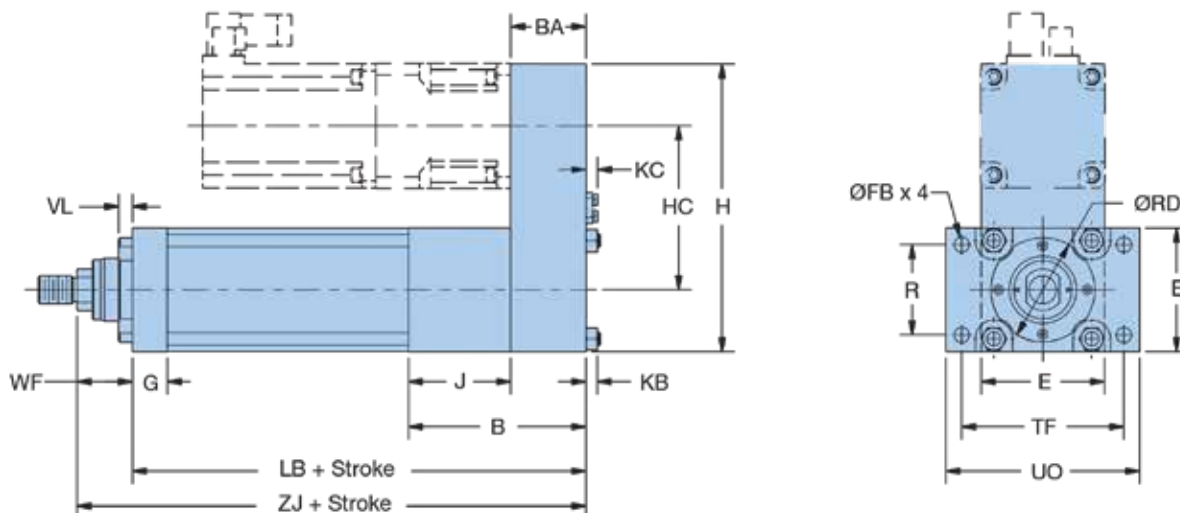

Dimensions — mm (in)

XFC Size	B	BA	E	Ø FB	G	H	HC	J	KB
075	106 (4.17)	44 (1.73)	76.2 (3.00)	9 (0.35)	22 (0.87)	174.2 (6.86)	98 (3.86)	62 (2.44)	6.5 (0.26)
090	128 (5.04)	54 (2.13)	88.9 (3.50)	11 (0.43)	25 (0.98)	206.9 (8.15)	118 (4.65)	74 (2.91)	8 (0.31)
115	154 (6.06)	63 (2.48)	114.3 (4.50)	14 (0.55)	30 (1.18)	271 (10.67)	156 (6.14)	91 (3.58)	10 (0.39)
140	180 (7.09)	72 (2.83)	139.7 (5.50)	18 (0.71)	35 (1.38)	332.2 (13.08)	192.5 (7.58)	108 (4.25)	13 (0.51)
165	211 (8.31)	88 (3.46)	165.1 (6.50)	21 (0.83)	40 (1.57)	379.1 (14.93)	224 (8.82)	123 (4.84)	18 (0.71)
190	252 (9.92)	100 (3.94)	190.5 (7.50)	22 (0.87)	50 (1.97)	455.5 (17.93)	265 (10.43)	152 (5.98)	18 (0.71)

XFC Size	Add Stroke								
	KC	R	Ø RD ₁₈	TF	UO	VL	WF	LB	ZJ
075	6.93 (0.27)	52 (2.05)	65 (2.559)	105 (4.13)	125 (4.92)	10 (0.39)	38 (1.50)	249.5 (9.82)	287.5 (11.32)
090	8.65 (0.34)	65 (2.56)	75 (2.953)	117 (4.61)	139.7 (5.50)	10 (0.39)	40 (1.57)	302 (11.89)	342 (13.46)
115	10.15 (0.40)	83 (3.27)	95 (3.740)	149 (5.87)	175 (6.89)	12 (0.47)	45 (1.77)	356 (14.02)	401 (15.79)
140	13.65 (0.54)	107 (4.21)	110 (4.331)	172 (6.77)	210 (8.27)	12 (0.47)	45 (1.77)	420 (16.54)	465 (18.31)
165	13.65 (0.54)	120 (4.72)	135 (5.315)	215 (8.46)	260 (10.24)	14 (0.55)	60 (2.36)	505 (19.88)	565 (22.24)
190	17.18 (0.68)	155 (6.10)	155 (5.315)	253 (9.96)	300 (11.81)	16 (0.63)	62 (2.44)	603 (23.74)	665 (26.18)

Foot Mount — Inline

Order Code



C

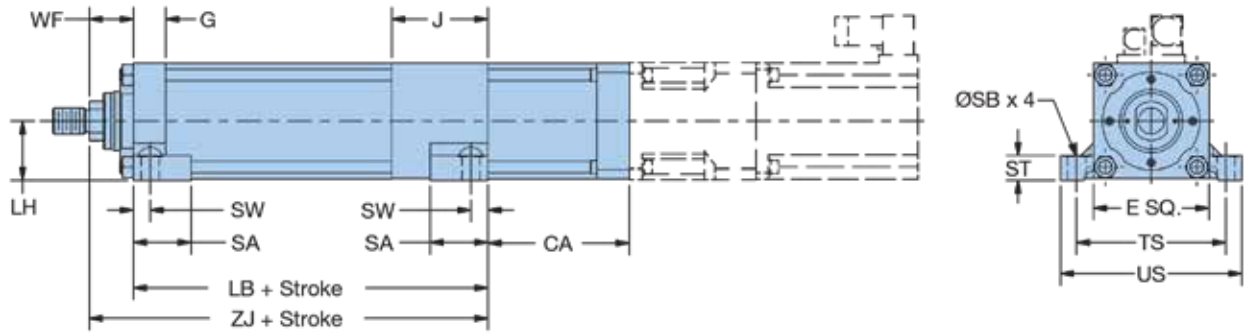

Dimensions — mm (in)

XFC Size	Add Stroke												
	E	G	J	LH _{h10}	SA	ØSB	ST	SW	TS	US	WF	LB	ZJ
075	76.2 (3.00)	22 (0.87)	62 (2.44)	39 (1.535)	33.3 (1.31)	11 (0.43)	12.7 (0.50)	11 (0.43)	97 (3.82)	114.3 (4.50)	38 (1.50)	205.5 (8.09)	243.5 (9.59)
090	88.9 (3.50)	25 (0.98)	74 (2.91)	45.5 (1.791)	44.5 (1.75)	14 (0.55)	19.1 (0.75)	13 (0.51)	115 (4.53)	139.7 (5.50)	40 (1.57)	248 (9.76)	288 (11.34)
115	114.3 (4.50)	30 (1.18)	91 (3.58)	58 (2.283)	57.2 (2.25)	18 (0.71)	25.4 (1.00)	15 (0.59)	155 (6.10)	184.2 (7.25)	45 (1.77)	293 (11.54)	338 (13.31)
140	139.7 (5.50)	35 (1.38)	108 (4.25)	71 (2.795)	57.2 (2.25)	18 (0.71)	25.4 (1.00)	18 (0.71)	175 (6.89)	209.6 (8.25)	45 (1.77)	348 (13.70)	393 (15.47)
165	165.1 (6.50)	40 (1.57)	123 (4.84)	83.5 (3.287)	73.0 (2.87)	22 (0.87)	31.8 (1.25)	20 (0.79)	210 (8.27)	254 (10.00)	60 (2.36)	417 (16.42)	477 (18.78)
190	190.5 (7.50)	50 (1.97)	152 (5.98)	96.5 (3.799)	92.1 (3.63)	26 (1.02)	38.1 (1.50)	25 (0.98)	260 (10.24)	304.8 (12.00)	62 (2.44)	503 (19.80)	565 (22.24)

Motor/Gearhead

XFC Size	Dimension CA								
	PS090	PS115	PS142	PS180	PS220	MPP115	MPP142	MPP190	MPP270
075	113 (4.45)	115 (4.53)	—	—	—	98 (3.86)	109 (4.29)	—	—
090	115 (4.53)	117 (4.61)	—	—	—	100 (3.94)	111 (4.37)	—	—
115	—	130 (5.12)	158 (6.22)	—	—	—	113 (4.45)	136 (5.35)	—
140	—	—	161 (6.34)	190 (7.48)	—	—	—	139 (5.47)	—
165	—	—	164 (6.46)	193 (7.60)	—	—	—	—	183 (7.20)
190	—	—	—	194 (7.64)	—	—	—	—	214 (8.43)

Electric Cylinders

Foot Mount — Parallel

Order Code

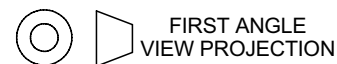

C

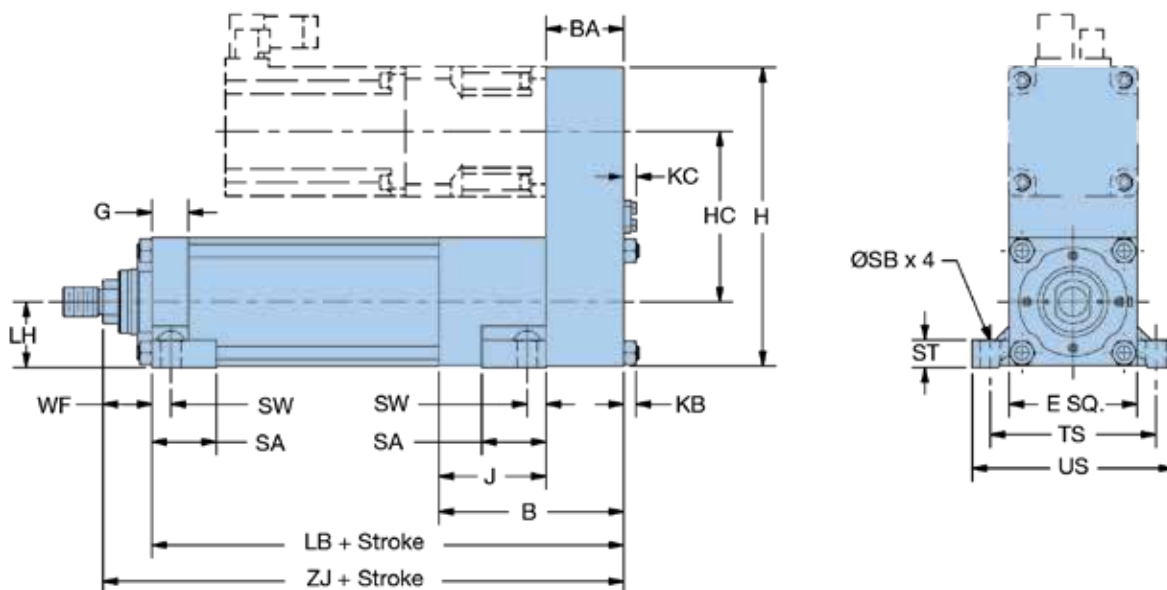

Dimensions — mm (in)

XFC Size	B	BA	E	G	H	HC	J	KB	KC
075	106 (4.17)	44 (1.73)	76.2 (3.00)	22 (0.87)	174.2 (6.86)	98 (3.86)	62 (2.44)	6.5 (0.26)	6.93 (0.27)
090	128 (5.04)	54 (2.13)	88.9 (3.50)	25 (0.98)	206.9 (8.15)	118 (4.65)	74 (2.91)	8 (0.31)	8.65 (0.34)
115	154 (6.06)	63 (2.48)	114.3 (4.50)	30 (1.18)	271 (10.67)	156 (6.14)	91 (3.58)	10 (0.39)	10.15 (0.40)
140	180 (7.09)	72 (2.83)	139.7 (5.50)	35 (1.38)	332.2 (13.08)	192.5 (7.58)	108 (4.25)	13 (0.51)	13.65 (0.54)
165	211 (8.31)	88 (3.46)	165.1 (6.50)	40 (1.57)	379.1 (14.93)	224 (8.82)	123 (4.84)	18 (0.71)	13.65 (0.54)
190	252 (9.92)	100 (3.94)	190.5 (7.50)	50 (1.97)	455.5 (17.93)	265 (10.43)	152 (5.98)	18 (0.71)	17.18 (0.68)

XFC Size	Add Stroke									
	LH _{h10}	SA	ØSB	ST	SW	TS	US	WF	LB	ZJ
075	39 (1.535)	33.3 (1.31)	11 (0.43)	12.7 (0.50)	11 (0.43)	97 (3.82)	114.3 (4.50)	38 (1.50)	249.5 (9.82)	287.5 (11.32)
090	45.5 (1.791)	44.5 (1.75)	14 (0.55)	19.1 (0.75)	13 (0.51)	115 (4.53)	139.7 (5.50)	40 (1.57)	302 (11.89)	342 (13.46)
115	58 (2.283)	57.2 (2.25)	18 (0.71)	25.4 (1.00)	15 (0.59)	155 (6.10)	184.2 (7.25)	45 (1.77)	356 (14.02)	401 (15.79)
140	71 (2.795)	57.2 (2.25)	18 (0.71)	25.4 (1.00)	18 (0.71)	175 (6.89)	209.6 (8.25)	45 (1.77)	420 (16.54)	465 (18.31)
165	83.5 (3.287)	73.0 (2.87)	22 (0.87)	31.8 (1.25)	20 (0.79)	210 (8.27)	254 (10.00)	60 (2.36)	505 (19.88)	565 (22.24)
190	96.5 (3.799)	92.1 (3.63)	26 (1.02)	38.1 (1.50)	25 (0.98)	260 (10.24)	304.8 (12.00)	62 (2.44)	603 (23.74)	665 (26.18)

Rear Trunnion Mount — Inline

Order Code



T

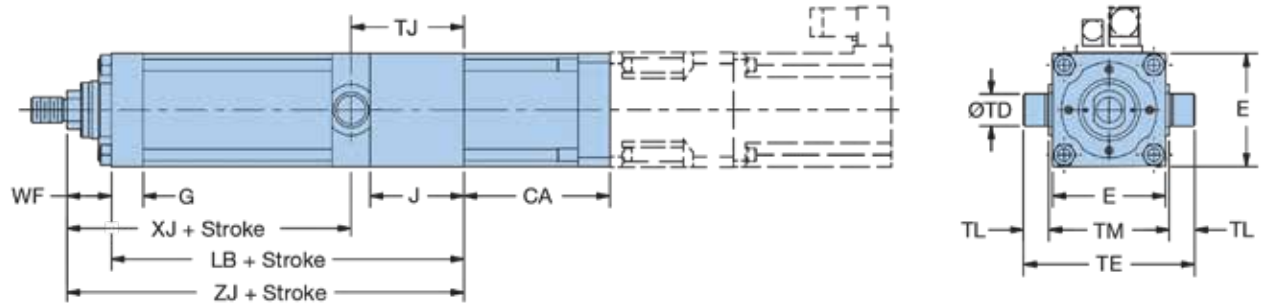

Dimensions — mm (in)

XFC Size	Add Stroke												
	E	G	J	TJ	∅ TD _{fg}	TL	TE	TM	WF	LB	XJ	ZJ	
075	76.2 (3.00)	22 (0.87)	62 (2.44)	74.5 (2.93)	20 (0.787)	16 (0.63)	112 (4.41)	80 (3.15)	38 (1.50)	205.5 (8.09)	169 (6.65)	243.5 (9.59)	
090	88.9 (3.50)	25 (0.98)	74 (2.91)	89 (3.50)	25 (0.984)	20 (0.79)	135 (5.32)	95 (3.74)	40 (1.57)	248 (9.76)	199 (7.83)	288 (11.34)	
115	114.3 (4.50)	30 (1.18)	91 (3.58)	111 (4.37)	32 (1.260)	25 (0.98)	170 (6.69)	120 (4.72)	45 (1.77)	293 (11.54)	227 (8.94)	338 (13.31)	
140	139.7 (5.50)	35 (1.38)	108 (4.25)	132 (5.20)	40 (1.575)	32 (1.26)	209.4 (8.244)	145.4 (5.72)	45 (1.77)	348 (13.70)	261 (10.28)	393 (15.47)	
165	165.1 (6.50)	40 (1.57)	123 (4.84)	152 (5.98)	50 (1.969)	40 (1.57)	250 (9.84)	170 (6.69)	60 (2.36)	417 (16.42)	325 (12.80)	477 (18.78)	
190	190.5 (7.50)	50 (1.97)	152 (5.98)	188 (7.40)	63 (2.480)	50 (1.97)	295.4 (11.63)	195.4 (7.69)	62 (2.44)	503 (19.80)	377 (14.84)	565 (22.24)	

Motor/Gearhead

XFC Size	Dimension CA								
	PS090	PS115	PS142	PS180	PS220	MPP115	MPP142	MPP190	MPP270
075	113 (4.45)	115 (4.53)	—	—	—	98 (3.86)	109 (4.29)	—	—
090	115 (4.53)	117 (4.61)	—	—	—	100 (3.94)	111 (4.37)	—	—
115	—	130 (5.12)	158 (6.22)	—	—	—	113 (4.45)	136 (5.35)	—
140	—	—	161 (6.34)	190 (7.48)	—	—	—	139 (5.47)	—
165	—	—	164 (6.46)	193 (7.60)	—	—	—	—	183 (7.20)
190	—	—	—	194 (7.64)	—	—	—	—	214 (8.43)

Electric Cylinders

Rear Trunnion Mount — Parallel

Order Code



T

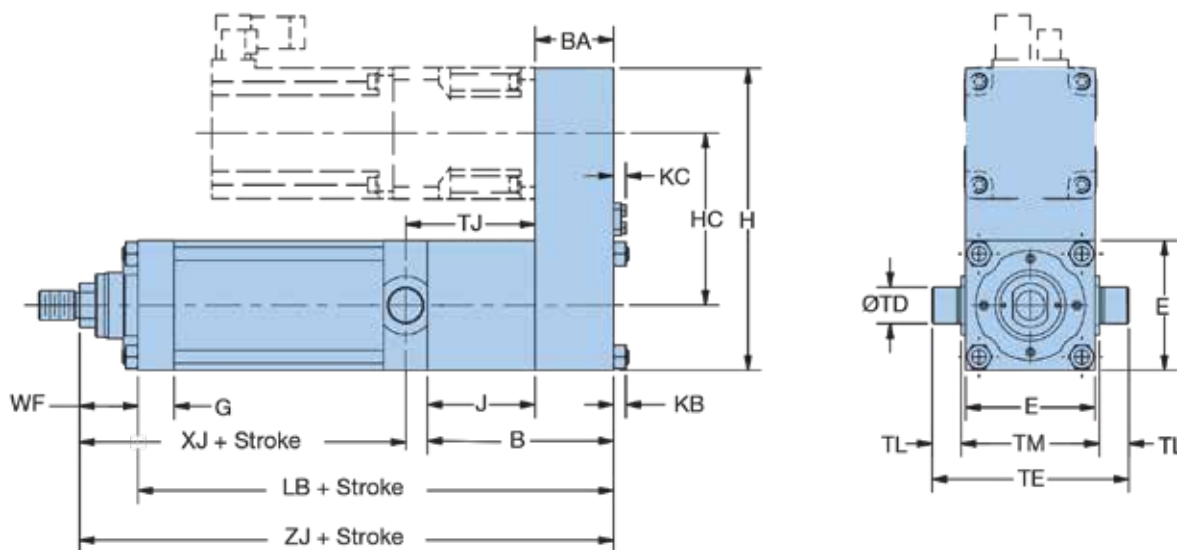

Dimensions — mm (in)

XFC Size	B	BA	E	G	H	HC	J	KB	KC
075	106 (4.17)	44 (1.73)	76.2 (3.00)	22 (0.87)	174.2 (6.86)	98 (3.86)	62 (2.44)	6.5 (0.26)	6.93 (0.27)
090	128 (5.04)	54 (2.13)	88.9 (3.50)	25 (0.98)	206.9 (8.15)	118 (4.65)	74 (2.91)	8 (0.31)	8.65 (0.34)
115	154 (6.06)	63 (2.48)	114.3 (4.50)	30 (1.18)	271 (10.67)	156 (6.14)	91 (3.58)	10 (0.39)	10.15 (0.40)
140	180 (7.09)	72 (2.83)	139.7 (5.50)	35 (1.38)	332.2 (13.08)	192.5 (7.58)	108 (4.25)	13 (0.51)	13.65 (0.54)
165	211 (8.31)	88 (3.46)	165.1 (6.50)	40 (1.57)	379.1 (14.93)	224 (8.82)	123 (4.84)	18 (0.71)	13.65 (0.54)
190	252 (9.92)	100 (3.94)	190.5 (7.50)	50 (1.97)	455.5 (17.93)	265 (10.43)	152 (5.98)	18 (0.71)	17.18 (0.68)

XFC Size	TJ	Ø TD _{f8}	TL	TE	TM	WF	Add Stroke		
							LB	XJ	ZJ
075	74.5 (2.93)	20 (0.787)	16 (0.63)	112 (4.41)	80 (3.15)	38 (1.50)	249.5 (9.82)	169 (6.65)	287.5 (11.32)
090	89 (3.50)	25 (0.984)	20 (0.79)	135 (5.32)	95 (3.74)	40 (1.57)	302 (11.89)	199 (7.83)	342 (13.46)
115	111 (4.37)	32 (1.260)	25 (0.98)	170 (6.69)	120 (4.72)	45 (1.77)	356 (14.02)	227 (8.94)	401 (15.79)
140	132 (5.20)	40 (1.575)	32 (1.26)	209.4 (8.244)	145.4 (5.72)	45 (1.77)	420 (16.54)	261 (10.28)	465 (18.31)
165	152 (5.98)	50 (1.969)	40 (1.57)	250 (9.84)	170 (6.69)	60 (2.36)	505 (19.88)	325 (12.80)	565 (22.24)
190	155 (6.10)	63 (2.480)	155 (5.315)	300 (11.81)	253 (9.96)	62 (2.44)	603 (23.74)	377 (14.84)	665 (26.18)

Rear Flange Mount — Parallel Only

Order Code



H

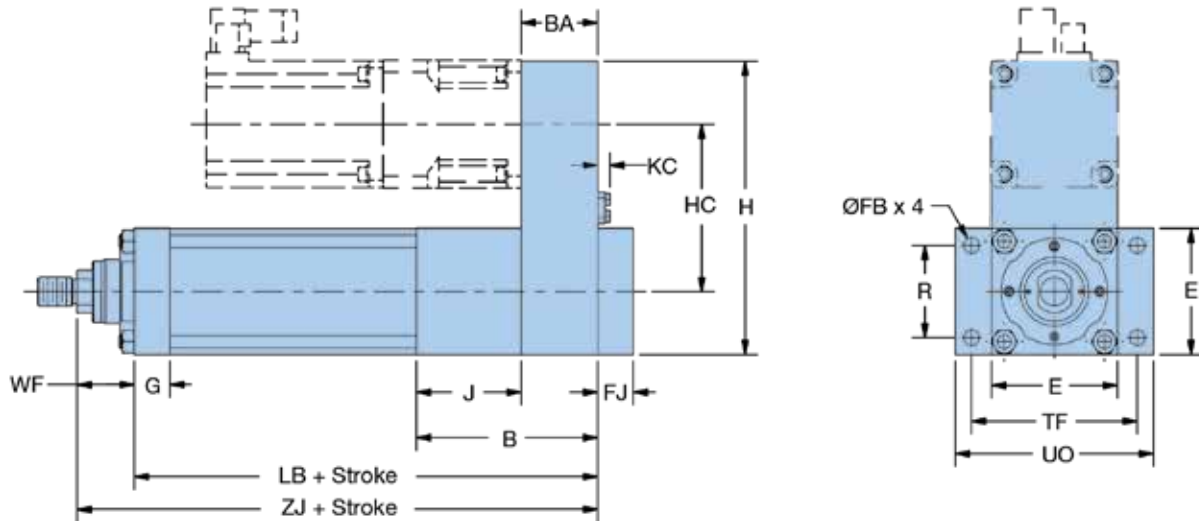

Dimensions — mm (in)

XFC Size	B	BA	E	Ø FB	FJ	G	H	HC
075	106 (4.17)	44 (1.73)	76.2 (3.00)	9 (0.35)	12 (0.47)	22 (0.87)	174.2 (6.86)	98 (3.86)
090	128 (5.04)	54 (2.13)	88.9 (3.50)	11 (0.43)	14 (0.55)	25 (0.98)	206.9 (8.15)	118 (4.65)
115	154 (6.06)	63 (2.48)	114.3 (4.50)	14 (0.55)	16 (0.63)	30 (1.18)	271 (10.67)	156 (6.14)
140	180 (7.09)	72 (2.83)	139.7 (5.50)	18 (0.71)	20 (0.79)	35 (1.38)	332.2 (13.08)	192.5 (7.58)
165	211 (8.31)	88 (3.46)	165.1 (6.50)	21 (0.83)	25 (0.98)	40 (1.57)	379.1 (14.93)	224 (8.82)
190	252 (9.92)	100 (3.94)	190.5 (7.50)	22 (0.87)	30 (1.18)	50 (1.97)	455.5 (17.93)	265 (10.43)

Add Stroke

XFC Size	J	KC	R	TF	UO	WF	LB	ZJ
075	62 (2.44)	6.93 (0.27)	52 (2.05)	105 (4.13)	125 (4.92)	38 (1.50)	249.5 (9.82)	287.5 (11.32)
090	74 (2.91)	8.65 (0.34)	65 (2.56)	117 (4.61)	139.7 (5.50)	40 (1.57)	302 (11.89)	342 (13.46)
115	91 (3.58)	10.15 (0.40)	83 (3.27)	149 (5.87)	175 (6.89)	45 (1.77)	356 (14.02)	401 (15.79)
140	108 (4.25)	13.65 (0.54)	107 (4.21)	172 (6.77)	210 (8.27)	45 (1.77)	420 (16.54)	465 (18.31)
165	123 (4.84)	13.65 (0.54)	120 (4.72)	215 (8.46)	260 (10.24)	60 (2.36)	505 (19.88)	565 (22.24)
190	152 (5.98)	17.18 (0.68)	155 (6.10)	253 (9.96)	300 (11.81)	62 (2.44)	603 (23.74)	665 (26.18)

Electric Cylinders

Rear Clevis Mount — Parallel Only

Order Code



B

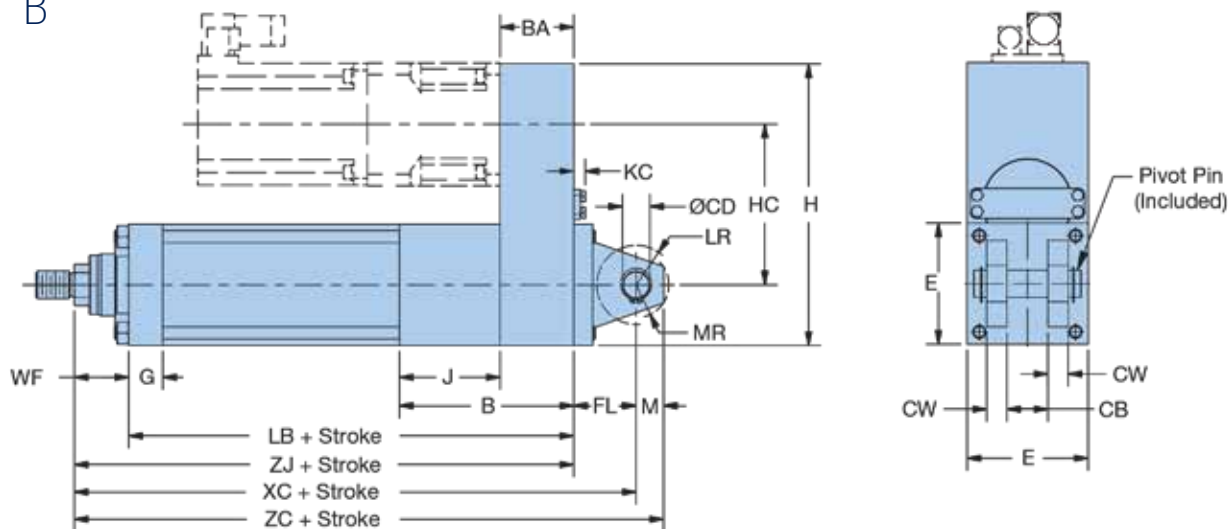

Dimensions — mm (in)

XFC Size	B	BA	CB	Ø CD _{H9}	CW	E	FL	G	H	HC
075	106 (4.17)	44 (1.73)	20 (0.79)	14 (0.551)	10 (0.39)	76.2 (3.00)	31 (1.22)	22 (0.87)	174.2 (6.86)	98 (3.86)
090	128 (5.04)	54 (2.13)	30 (1.18)	20 (0.787)	15 (0.59)	88.9 (3.50)	46 (1.81)	25 (0.98)	206.9 (8.15)	118 (4.65)
115	154 (6.06)	63 (2.48)	30 (1.18)	20 (0.787)	15 (0.59)	114.3 (4.50)	48 (1.89)	30 (1.18)	271 (10.67)	156 (6.14)
140	180 (7.09)	72 (2.83)	40 (1.57)	28 (1.102)	20 (0.79)	139.7 (5.50)	59 (2.32)	35 (1.38)	332.2 (13.08)	192.5 (7.58)
165	211 (8.31)	88 (3.46)	50 (1.97)	36 (1.417)	25 (0.98)	165.1 (6.50)	79 (3.11)	40 (1.57)	379.1 (14.93)	224 (8.82)
190	252 (9.92)	100 (3.94)	60 (2.36)	45 (1.772)	30 (1.18)	190.5 (7.50)	87 (3.43)	50 (1.97)	455.5 (17.93)	265 (10.43)

Add Stroke

XFC Size	J	KC	LR	M	MR	WF	LB	XC	ZC	ZJ
075	62 (2.44)	6.93 (0.27)	17 (0.67)	14 (0.55)	17 (0.67)	38 (1.50)	249.5 (9.82)	318.5 (12.54)	332.5 (13.09)	287.5 (11.32)
090	74 (2.91)	8.65 (0.34)	29 (1.14)	20 (0.79)	25 (0.98)	40 (1.57)	302 (11.89)	388 (15.28)	408 (16.06)	342 (13.46)
115	91 (3.58)	10.15 (0.40)	29 (1.14)	20 (0.79)	25 (0.98)	45 (1.77)	356 (14.02)	449 (17.68)	469 (18.46)	401 (15.79)
140	108 (4.25)	13.65 (0.54)	34 (1.34)	28 (1.10)	34 (1.34)	45 (1.77)	420 (16.54)	524 (20.63)	552 (21.73)	465 (18.31)
165	123 (4.84)	13.65 (0.54)	50 (1.97)	36 (1.42)	45 (1.77)	60 (2.36)	505 (19.88)	644 (25.35)	680 (26.77)	565 (22.24)
190	152 (5.98)	17.18 (0.68)	53 (2.09)	45 (1.77)	54 (2.13)	62 (2.44)	603 (23.74)	752 (29.61)	797 (31.38)	665 (26.18)

Male Rod End

Order Code



- A Metric Thread
- B Imperial Thread

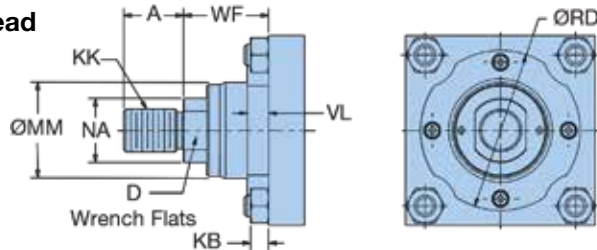

Dimensions – mm (in)

XFC Size	KK									
	A	D	KB	A	B	ØMM	NA	ØRD _{f8}	VL	WF
075	22 (0.87)	19 (0.75)	6.5 (0.26)	M16x1.5	5/8-18	36 (1.42)	24 (0.94)	65 (2.558)	10 (0.39)	38 (1.50)
090	28 (1.10)	24 (0.94)	8 (0.31)	M20x1.5	3/4-16	45 (1.77)	30 (1.18)	75 (2.952)	10 (0.39)	40 (1.57)
115	36 (1.42)	32 (1.26)	10 (0.39)	M27x2	1-14	56 (2.20)	40 (1.57)	95 (3.739)	12 (0.47)	45 (1.77)
140	45 (1.77)	39 (1.54)	13 (0.51)	M33x2	1 1/4-12	70 (2.76)	49 (1.93)	110 (4.329)	12 (0.47)	45 (1.77)
165	56 (2.21)	48 (1.89)	18 (0.71)	M42x2	1 1/2-12	90 (3.54)	60 (2.36)	135 (5.313)	14 (0.55)	60 (2.36)
190	63 (2.48)	55 (2.17)	18 (0.71)	M48x2	1 3/4-12	110 (4.33)	70 (2.76)	155 (6.101)	16 (0.63)	62 (2.44)

Rod Eye

Order Code

C

Dimensions – mm (in)

XFC Size	AW	ØCB	ØCK _{H9}	EM _{h13}	ER _{MAX}	LE	ØMM
075	48 (1.89)	32 (1.26)	14 (0.551)	20 (0.787)	16 (0.63)	19 (0.75)	36 (1.42)
090	61 (2.40)	40 (1.57)	20 (0.787)	30 (1.181)	20 (0.79)	32 (1.26)	45 (1.77)
115	66 (2.60)	45 (1.77)	20 (0.787)	30 (1.181)	23 (0.89)	32 (1.26)	56 (2.20)
140	73 (2.87)	60 (2.36)	28 (1.102)	40 (1.575)	30 (1.18)	39 (1.53)	70 (2.76)
165	99 (3.90)	80 (3.15)	36 (1.417)	50 (1.969)	40 (1.57)	54 (2.13)	90 (3.54)
190	104 (4.09)	100 (3.94)	45 (1.772)	60 (2.362)	50 (1.97)	57 (2.24)	110 (4.33)

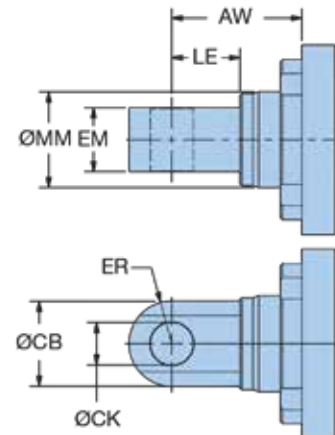

Mounting Accessories



Dimensions – mm (in)

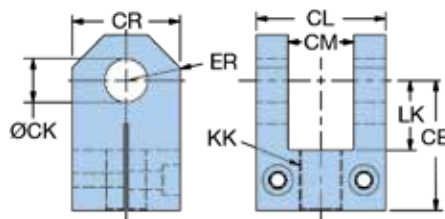

Rod Clevis

XFC Size	Part No.	CE	CL	CM _{A16}	ØCK _{H9}	CR	LK _{MIN}	ER _{MAX}	KK	Load Rating kN (lb)
075	0950250075	41 (1.61)	40 (1.57)	20 (0.787)	14 (0.551)	30 (1.18)	19 (0.75)	15.53 (0.61)	M16x1.5	20 (4,500)
090	0950250090	60 (2.36)	60 (2.36)	30 (1.181)	20 (0.787)	50 (1.97)	32 (1.26)	25.32 (1.00)	M20x1.5	34 (7,500)
115	0950250115	68 (2.68)	60 (2.36)	30 (1.181)	20 (0.787)	50 (1.97)	32 (1.26)	25.71 (1.01)	M27x2	54 (12,000)
140	0950250140	84 (3.31)	83 (3.27)	40 (1.575)	28 (1.102)	60 (2.36)	39 (1.54)	32.50 (1.28)	M33x2	80 (17,500)
165	0950250165	110 (4.33)	103 (4.06)	50 (1.969)	36 (1.417)	76 (2.99)	54 (2.13)	41.04 (1.62)	M42x2	120 (26,500)
190	0950250190	120 (4.72)	123 (4.84)	60 (2.362)	45 (1.772)	101.5 (4.00)	57 (2.24)	51.83 (2.04)	M48x2	178 (40,000)

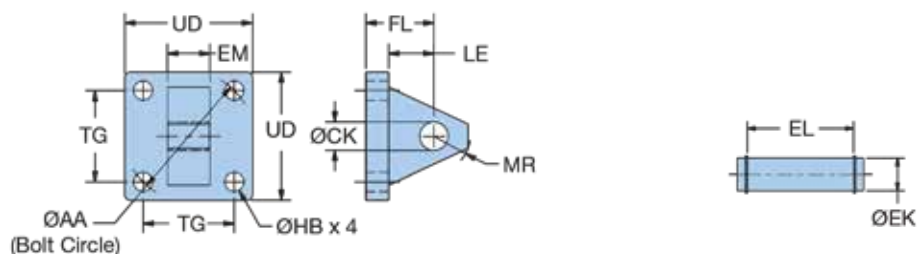

Clevis Bracket

Pivot Pin

XFC Size	Part No.	Ø									Part No.	Ø	
		ØAA	CK _{H9}	EM	FL	ØHB	LE _{MIN}	MR _{MAX}	TG	UD		EK _{f8}	EL
075	1448100000	59 (2.32)	14 (0.551)	20 (0.79)	29 (1.14)	9 (0.35)	19 (0.75)	17 (0.67)	41.7 (1.64)	64 (2.52)	1434790000	14 (0.551)	45 (1.77)
090	1448110000	74 (2.91)	20 (0.787)	30 (1.18)	48 (1.89)	13.5 (0.53)	32 (1.26)	29 (1.14)	52.3 (2.06)	75 (2.95)	1434800000	20 (0.787)	66 (2.60)
115	1448120000	91 (3.58)	20 (0.787)	30 (1.18)	48 (1.89)	13.5 (0.53)	32 (1.26)	29 (1.14)	64.3 (2.53)	90 (3.54)	1434800000	20 (0.787)	66 (2.60)
140	1448130000	117 (4.61)	28 (1.102)	40 (1.58)	59 (2.32)	17.5 (0.69)	39 (1.54)	34 (1.34)	82.7 (3.26)	115 (4.53)	1434810000	28 (1.102)	87 (3.43)
165	1448140000	137 (5.39)	36 (1.417)	50 (1.97)	79 (3.11)	17.5 (0.69)	54 (2.13)	50 (1.97)	96.9 (3.82)	127 (5.00)	1434820000	36 (1.417)	107 (4.21)
190	1448150000	178 (7.01)	45 (1.772)	60 (2.36)	87 (3.43)	26 (1.02)	57 (2.24)	53 (2.09)	125.9 (4.96)	165 (6.50)	1434830000	45 (1.772)	129 (5.08)

OPTIONS & ACCESSORIES

Motors, Gearheads & Adapter Plates

Motor and gearhead selection is critical to the performance of the XFC electromechanical cylinder and must be sized based on the application requirements.

The tables below and on the next page provide information on Parker MPP motors or PS Series gearheads that are appropriate with the XFC.

A motor-only selection is typically used in high-speed/low-force applications, whereas a motor/

gearhead combination is beneficial for slow speed/high force.

Standard configurations are available if a number is listed in the adapter plate columns (MAP, LAP). This number represents the adapter plate width and corresponds to the

appropriate size motor and gearhead.

If the number is zero, the motor or gearhead combination is possible, but an adapter plate is not required. A dash indicates that a suitable combination is not available as a standard configuration.

Consult the factory to inquire about other options or configurations.

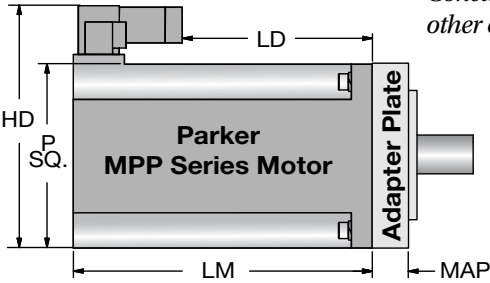

MPP Series Motors

Dimensions – mm (in)

MPP Motor		MAP																	
Size	Length	LM	LD	HD	P	Inline						Parallel							
						075	090	115	140	165	190	075	090	115	140	165	190		
115	2	152.4 (6.00)	89.2 (3.51)																
	3	177.8 (7.00)	115.2 (4.54)	159.0 (6.26)	113.0 (4.45)	0.0	0.0					12 (0.47)	12 (0.47)						
	4	203.2 (8.00)	140.2 (5.52)																
142	2	172.9 (6.81)	109.9 (4.33)																
	4	223.7 (8.81)	160.8 (6.33)	188.8 (7.43)	142.7 (5.62)	16 (0.63)	16 (0.63)	16 (0.63)					16 (0.63)	16 (0.63)					
	6	274.5 (10.81)	211.9 (8.34)																
	8	325.3 (12.81)	261.9 (10.31)																
190	4	224.0 (8.82)	110.3 (4.34)																
	6	275.0 (10.83)	161.3 (6.35)	260.1 (10.24)	184.9 (7.28)			25 (0.98)	25 (0.98)					25 (0.98)	25 (0.98)				
	8	325.3 (12.81)	211.3 (8.32)																
270	6	293.3 (11.55)	175.3 (6.90)	335.9 (13.22)	266.7 (10.50)				30 (1.18)	30 (1.18)							30 (1.18)		
	8	344.1 (13.55)	255.5 (10.06)																

Note: Make sure the output torque on the motor is sufficient for the application. MPP torque information can be found at www.parkermotion.com

Motor Brake Option

For vertical applications, a static brake should be used to resist back-driving the screw mechanism. A motor brake increases the overall length of the motor as indicated in the chart.

Brake Option Additional Motor Length

Motor size	092	100	115	142	190	270
LM and LD	34.5	48.5	48.5	51.6	89.0	127.0
Increase by:	(1.36)	(1.91)	(1.91)	(2.03)	(3.50)	(5.00)

For specific motor holding torque, refer to MPP motor data at parkermotion.com

Electric Cylinders

PS Series Gearheads

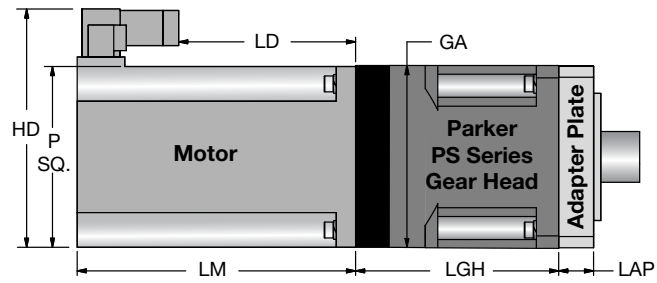

Dimensions – mm (in)

Gear size	MPP Motor		LM	LD	HD	P	GA	LGH	LAP ¹					
	Size	Length							075	090	115	140	165	190
PS90	092	1	127.2 (5.01)	64.2 (2.53)	136.4 (5.37)	88.8 (3.50)	90 (3.54)	89.5 (3.52)	19 (0.75)	0.0	—	—	—	—
		2	152.6 (6.01)	90.2 (3.55)							—	—	—	—
		3	178.0 (7.01)	115.2 (4.52)							—	—	—	—
	100	2	149.1 (5.87)	86.2 (3.39)	143.8 (5.66)	97.8 (3.85)	98 (3.86)	—			—	—	—	
3		174.5 (6.87)	111.2 (4.38)	—	—	—	—							
PS115	092	1	127.2 (5.01)	64.2 (2.53)	136.4 (5.37)	88.8 (3.50)	90 (3.54)	89.5 (3.52)	24 (0.94)	22 (0.87)	0.0	—	—	—
		2	152.4 (6.00)	89.2 (3.51)								—	—	—
		3	177.8 (7.00)	115.2 (4.54)								—	—	—
	100	2	149.1 (5.87)	86.2 (3.39)	143.8 (5.66)	97.8 (3.85)	115 (4.53)	114.2 (4.50)				—	—	—
		3	174.5 (6.87)	111.2 (4.38)	—	—	—	—				—	—	
		4	203.2 (8.00)	140.2 (5.52)	—	—	—	—				—	—	
PS142	100	2	149.1 (5.87)	86.2 (3.39)	143.8 (5.66)	97.8 (3.85)	142 (5.59)	133.7 (5.26)	—	—	29 (1.14)	5.0 (0.20)	5.0 (0.20)	—
		3	174.5 (6.87)	111.2 (4.38)	—	—			—	—				
		4	203.2 (8.00)	140.2 (5.52)	—	—			—	—				
	115	2	152.4 (6.00)	89.2 (3.51)	159.0 (6.26)	113.0 (4.45)	182 (7.17)	151 (5.95)	—	—	—	—	—	—
		3	177.8 (7.00)	115.2 (4.54)	—	—			—	—				
		4	203.2 (8.00)	140.2 (5.52)	—	—			—	—				
		6	274.5 (10.81)	211.9 (8.34)	188.8 (7.43)	142.7 (5.62)			—	—	—	—	—	
		8	325.3 (12.81)	261.9 (10.31)	—	—			—	—				
PS180	115	2	152.4 (6.00)	89.2 (3.51)	159.0 (6.26)	113.0 (4.45)	182 (7.17)	151 (5.95)	—	—	—	—	—	—
		3	177.8 (7.00)	115.2 (4.54)	—	—			—	—				
		4	203.2 (8.00)	140.2 (5.52)	—	—			—	—				
	142	2	172.9 (6.81)	109.9 (4.33)	—	—	—	—	—	—	—	—	—	
		4	223.7 (8.81)	160.8 (6.33)	188.8 (7.43)	142.7 (5.62)	—	—	—	—	—	—		
		6	274.5 (10.81)	211.9 (8.34)	—	—	—	—	—	—	—	—		
		8	325.3 (12.81)	261.9 (10.31)	—	—	—	—	—	—	—	—		
		4	224.0 (8.82)	110.3 (4.34)	260.1 (10.24)	184.9 (7.28)	—	—	—	—	—	—		
190	6	275.0 (10.83)	161.3 (6.35)	—	—	—	—	—	—	—	—	—		
	8	325.3 (12.81)	211.3 (8.32)	—	—	—	—	—	—	—	—			
PS220	190	4	224.0 (8.82)	110.3 (4.34)	260.1 (10.24)	184.9 (7.28)	220 (8.66)	212 (8.35)	—	—	—	—	—	—
		6	275.0 (10.83)	161.3 (6.35)	—	—			—	—	—	—	—	
	270	6	293.3 (11.55)	175.3 (6.90)	335.9 (13.22)	266.7 (10.50)	—	—	—	—	—	—	—	
		8	344.1 (13.55)	255.5 (10.06)	—	—	—	—	—	—	—	—	36 (1.42)	

¹ LAP dimension is required for parallel mounting only; 0.0 means no adapter plate required. Inline configurations do not require adapter plates.

Note: Make sure the output torque on the gear head is sufficient for the application. PS torque information can be found at www.parkermotion.com



Compax3 Power Range

Compax3 Device	Current A_{RMS}		Supply Voltage
	I_{cont}	$I_{beak} (<5s)$	
S025V2	2.5	5.5	1Ø 230/240VAC
S063V2	6.3	12.6	
S100V2	10	20	3Ø 230/240VAC
S150V2	15	30	
S038V4 ¹	3.8	9.0	3Ø 400/480VAC
S075V4 ¹	7.5	15	
S150V4 ¹	15	30	
S300V4 ¹	30	60	3Ø 400/480VAC
H050V4 ¹	50	75	
H090V4 ¹	90	135	
H125V4 ¹	125	187.5	
H155V4 ¹	155	232.5	

¹Rated at 400 VAC

Standard Features

- Power range of 1kW...75kW
- 8 digital inputs, 4 digital outputs
- Available with ETHERNET Powerlink, and EtherCat
- RS232 / RS485 – interfaces
- 2 analog inputs (+/-10V, 14 bits)
- 2 analog outputs (+/-10V, 8 bits)
- Encoder input or output
- Motors supported:
 - Synchronous servo motors
 - Asynchronous motors
 - Linear motors
 - Torque motors
- Position sensing at the motor shaft via:
 - Resolver
 - Rotary/linear encoder
 - Sine-cosine feedback
 - Hiperface interface
 - EnDat 2.2 interface
 - Compatible with most feedback systems
- Support for SSI feedback

Extensions

- Real-time bus for axis coupling
- Scalable technology and control functions
- Integrated or external controls

Functions (summary)

- Programmable according to IEC61131-3
- Reg-related positioning, electronic gearing, dynamic positioning (motion superimposition) and torque-force control
- Cam – modular, with coupling and decoupling functions, cam switching mechanism

Technologies

- T10: Step/Direction and Analog Command Input
- T11: Positioning indexer
- T30: IEC61131-3 Positioning with function modules according to PLCopen
- T40: IEC61131-3 Positioning plus Cam function modules

For further information on Compax3 Drive/Controllers or assistance with sizing and selection, please consult parkermotion.com, or consult the factory

Complementary Parker Products

Parker offers HMI solutions for any application from simple push button replacement through sophisticated networking, multimedia and data logging requirements. Products range from entry level embedded displays through full Windows-based Industrial PC solutions.



Parker offers a broad family of motors with unparalleled performance, a torque range of 1.2 in-lbs to 4000 in-lbs and complete customization capabilities. For higher torque requirements, Parker's Stealth gearheads are the perfect solution.

Solid State Switches



Global Drop-In Solid State Switches

Specifications

Switch Classification	Standard PNP or NPN
Type	Electronic
Output Function	Normally Open/Closed
Switch Output	PNP/NPN
Operating Voltage	10 - 30VDC
Continuous Current	100 mA max.
Response Sensitivity	28 Gauss min.
Switching Frequency	5 KHz
Power Consumption	10 mA max.
Voltage Drop	2.5 VDC max.
Ripple	10% of Operating Voltage
Hysteresis	1.5 mm max.
Repeatability	0.1 mm max.
EMC	EN 60 947-5-2
Short-circuit Protection	Yes
Power-up Pulse Suppression	Yes
Reverse Polarity Protection	Yes
Enclosure Rating	IP68
Shock and Vibration Stress	30g, 11 ms, 10 to 55Hz, 1 mm
Operating Temperature Range	-25°C to +75°C (-13°F to +167°F)
Housing Material	PA 12 Black
Connector Cable	PVC
Connector	PUR

Global solid state switch outputs may be influenced by an external magnetic field. Care must be taken to avoid external magnetic field exposure.

Solid State Switch Ordering Information

	PNP*		NPN	
	Nomally Open	Normally Closed	Normally Open	Normally Closed
3 m Flying Leads	P8S-GPFIK	P8S-GQFIK	P8S-GNFIK	P8S-GMFIK
10 m Flying Leads	P8S-GPFTX	—	P8S-GNFTX	—
0.3 m Lead with 8 mm connector	P8S-GPSHX	P8S-GQSHX	P8S-GNSHX	P8S-GMSHM
1 m Lead with 8 mm connector	P8S-GPSCX	—	P8S-GNSCX	—
Compax3 Compatible	Yes	Yes	No	No

*PNP needed for Compax3 Servo Drive.

Electric
Cylinders

Wiring Connection

Flying Lead or 8 mm Connector (shown)

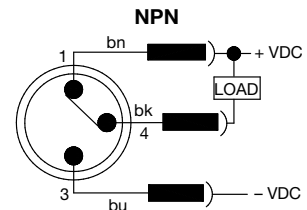
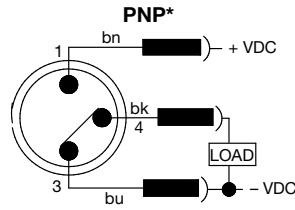

**PNP needed for Compax3 Servo Drive*

Pin	Wire	Function
1	Brown	Operating Voltage (+VDC)
4	Black	Output signal (N.O.)
3	Blue	-VDC

Dimensions – mm

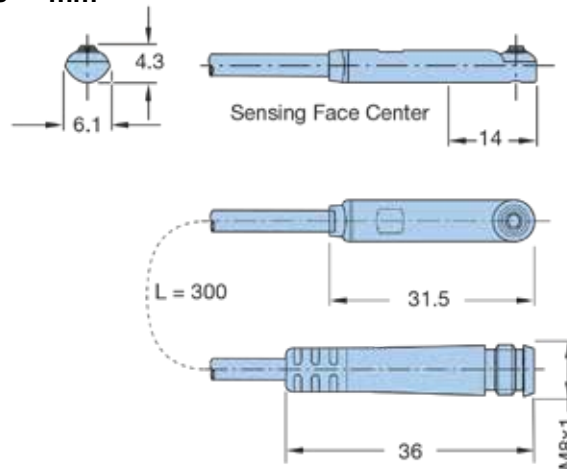

8 mm Threaded Cord Set to Flying Leads

086620T002	2 meter
086620T005	5 meter

Tie Rod Bracket Assembly

Global switch bracket fits XFC 075 - 115 cylinders. Global switches and bracket assemblies must be ordered separately.

P8S-TMA0X	Tie Rod Bracket Assembly
------------------	--------------------------

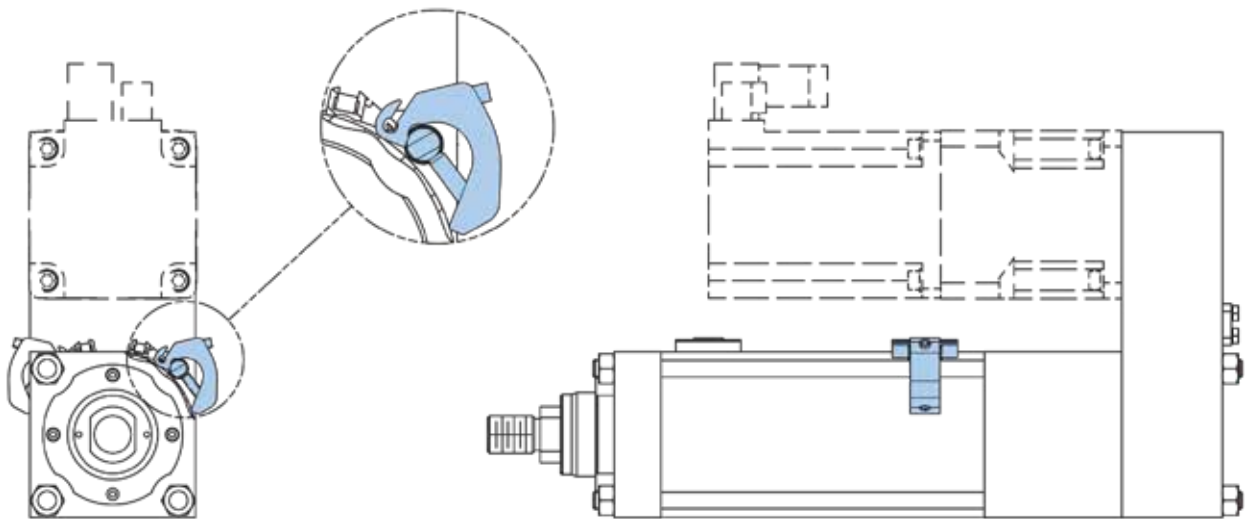

ORDERING INFORMATION

XFC

Select an order code from each of the numbered fields to create a complete XFX model order number. Include hyphens and non-selective characters as shown in example below.

① ② ③ ④ ⑤ ⑥ ⑦ ⑧ ⑨ ⑩ ⑪ ⑫ ⑬ ⑭ ⑮ ⑯

Order Example: XFC 075 LA 05 J N A A N XXXX - A 03 - A09A A 1 - A

① **Series**

XFC Extreme Force Cylinder

② **Frame Size**

- 075** 75 mm
- 090** 90 mm
- 115** 115 mm
- 165** 165 mm
- 190** 190 mm

③ **Configuration**

Inline Motor

- LA** Mounting Position A*
- LB** Mounting Position B*
- LC** Mounting Position C*
- LD** Mounting Position D*

Parallel Motor

- PA** Mounting Position A*
- PB** Mounting Position B*
- PC** Mounting Position C*
- PD** Mounting Position D*

④ **Screw Lead**

- 05** 5 mm Lead (XFC075, 090, 115, 140)
- 10** 10 mm Lead (XFC075, 090, 115, 140, 165, 190)
- 20** 20 mm Lead (XFC165 & 190)

⑤ **Primary Mount**

⑥ **Secondary Mount**

Inline Motor Configuration

- C** Foot Mount
- J** Front Flange Mount
- K** Extended Tie Rod Mount (Front)
- T** Rear Trunnion Mount
- N** No Secondary Mount

Parallel Motor Configuration

- B** Rear Clevis
- C** Foot Mount
- H** Rear Flange
- J** Front Flange Mount
- K** Extended Tie Rod Mount (Front)
- L** Extended Tie Rod Mount (Rear)
- M** Extended Tie Rod Mount (Front & Rear)
- T** Rear Trunnion Mount
- N** No Secondary Mount

⑦ **Rod End**

- A** Metric Thread – Male End
- B** Imperial Thread – Male End
- C** Rod Eye
- X** Special

⑧ **Lubrication**

- A** Oil Filled Port Position A*
- B** Oil Filled Port Position B*
- C** Oil Filled Port Position C*
- D** Oil Filled Port Position D*
- E** Grease Filled (required for vertical applications)

*Refer to illustration at left. For parallel configurations, the oil fill port position and the motor mount position cannot be the same.

⑨ **Options**

- A** Prepped for Limit Switches*
- B** Fluorocarbon Seals
- C** Fluorocarbon Seals and Limit Switch Ready*
- N** None

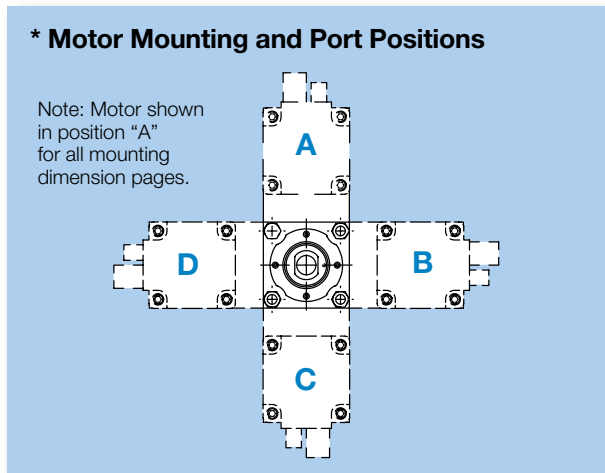

Electric Cylinders

*Options A and C are only available with XFC 075, 090 and 115 with grease-filled lubrication

⑩ Stroke Length – mm

XXXX 50 – 2000 mm (See Specifications for max stroke by bore size. For stroke <50 or >2000 please consult factory)

⑪ Gearhead Frame Size ¹⁾

- A** PS90 Frame for Size XFC075 & 090
- B** PS115 Frame for Size XFC075, 090 & 115
- C** PS142 Frame for Size XFC115, 140 & 165
- D** PS180 Frame for Size XFC140, 165 & 190
- E** PS220 Frame for Size XFC190
- X** Special
- N** No Gearhead (Motor only)

⑫ Gearhead Ratio

- 00** No Gearhead
- 03** Gearhead with 3:1 ratio
- 04** Gearhead with 4:1 ratio
- 05** Gearhead with 5:1 ratio
- 07** Gearhead with 7:1 ratio
- 10** Gearhead with 10:1 ratio
- XX** Custom Gear Ratio

⑬ Motor Selection* ¹⁾

240 VAC		460 VAC	
A09A	MPP0921C	A09B	MPP0921R
A09C	MPP0922D	A09D	MPP0922R
A09E	MPP0923D	A09F	MPP0923R
A10A	MPP1002D	A10B	MPP1002R
A10C	MPP1003C	A10D	MPP1003R
A11A	MPP1152D	A11B	MPP1152R
A11C	MPP1153C	A11D	MPP1153R
A11E	MPP1154B	A11F	MPP1154P
A14A	MPP1422C	A14B	MPP1422R
A14C	MPP1424C	A14D	MPP1424R
A14E	MPP1426B	A14F	MPP1426P
—	—	A14G	MPP1428Q
—	—	A19A	MPP1904P
A19B	MPP1906B	A19C	MPP1906P
—	—	A19D	MPP1908P
—	—	A27A	MPP2706P
—	—	A27B	MPP2708N

X00X Special **X00X** Special

*Refer to Motors, Gearheads & Adapter Plates in Options & Accessories for motor pairing options by bore size.

⑭ Motor Feedback ²⁾

- A** 2000 Count Encoder (1E)
- B** 2000 Count Encoder – Serial Interface (3E)
- C** Single Speed Resolver (41)
- D** Multi-Turn Absolute Encoder (6S)
- E** Single-Turn Absolute Encoder (9S)
- N** No Motor or Special Motor

⑮ Motor Options* ²⁾

- 1** No Brake
- 2** 24 VDC Brake (B)
- 3** Shaft Seal (V)
- 4** 24 VDC Brake (B) and Shaft Seal (V)
- 0** No Motor or Special Motor

*Brake required for vertical applications

⑯ Revision Identifier

- A** Standard Cylinder
Anti-rotation Option (When selecting anti-rotation option, grease filled option must also be selected [Option “E” from ⑧ Lubrication section]. Consult factory for rotation torque greater than stated catalog values in Specifications)
- B**

1) Includes proper mounting surface for selected gearhead and motor.
2) For customer supplied motors, not provided by Parker, select option “N” for **Motor Feedback** and “0” for **Motor Options**.

Free sizing and selection support
from Virtual Engineer at
parker.com/VirtualEngineer

